

PREISLISTE 2015 in Euro

Badlinie FLOW von ARCA



SLICE | FLOW | TOUCH | AIKON | MAKRO | PLANAR



GRIGIO PIOMBO



ANTRACITE



NERO



MOKA

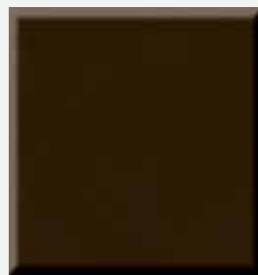

CACAO



ALBICOCCA



CREMA



AVORIO



GIALLO CANAPA



VANIGLIA



CAMOSCIO



ROSSO FORMULA



ROSSO



MATTONE



BORDEAUX



ROSA ALBA



LAVANDA



ANICE



AZZURRO VELO



AZZURRO ARTICO



VERDE GIADA



VERDE SALVIA



VERDE OASI



VERDE MELA

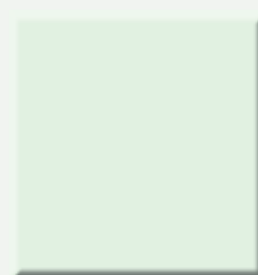

VERDE MALVA

SLICE | FLOW | TOUCH | AIKON | MAKRO | PLANAR



ORO LUX



BRONZO LUX



ARGENTO LUX



GRIGIO NUVOLA



GRIGIO NEBBIA



TORTORA



TERRA CHIARA



BEIGE ECRU



VISONE



AVANA



GIALLO MELONE



GIALLO DUNA



MIELE

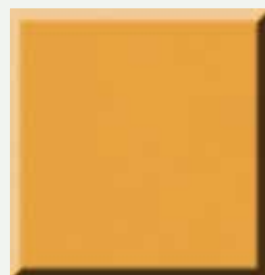

ARANCIO PASTELLO



ARANCIO



MELANZANA



PORPORA



VIOLETTO



PURPLE



ROSA TRAMONTO



GLICINE



BLU ELETTRICO



BLU PACIFICO



CADMIO



VERDE CANNE

SHAKE



BIANCO



CORDA



AZZURRO VELO



LAVANDA

Diese Oberflächen sind für die Linie FLOW nicht lieferbar.



GRIGIO METALLIZZATO



VERDE ACIDO



ARANCIO

GAMMA COLORI **ECOWOOD**

FLOW



MITO SILVER



MITO BROWN



MITO CARBON



ABETE VINTAGE

L63,8

PORTALAVABO SOSPESO

- 1 Cassettone L61,6
- 1 Fianco tamponamento laccato L2,2

PROF CODICE

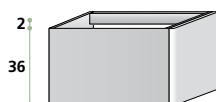
FLOWfrontale
ecowoodfrontale laccato
o essenza rovere tinto

42	FL/PL36.06142	470	560
50	FL/PL36.06150	500	590

L72,6

PORTALAVABO SOSPESO

- 1 Cassettone L70,4
- 1 Fianco tamponamento laccato L2,2

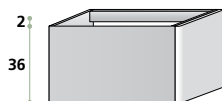

42	FL/PL36.07042	490	580
50	FL/PL36.07050	520	620

FIANCO AGGIUNTIVO LACCATO
H36 L2,2

42	FL/FT036.42	SOLO LACCATO	50
50	FL/FT036.50	SOLO LACCATO	57

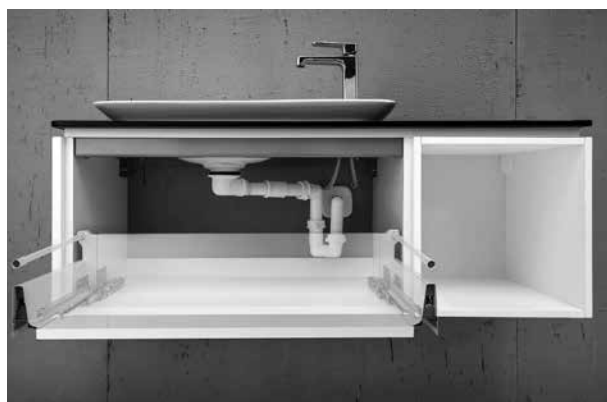

I PORTALAVABI FLOW VENGONO FORNITI DI SERIE CON SIFONE SALVASPAZIO COMPLETO DI PILETTA UP-DOWN

NON È NECESSARIO CHE LO SCARICO SIA IN LINEA CON QUELLO DEL LAVABO COME QUESTO ESEMPIO

L90,2

PORTALAVABO SOSPESO

- 1 Cassettone L88
- 1 Fianco tamponamento laccato L2,2

PROF CODICE

FLOW

frontale
 ecowood

frontale laccato
 o essenza rovere tinto

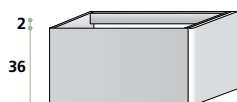

42	FL/PL36.8842	520	630
50	FL/PL36.8850	550	650

L99

PORTALAVABO SOSPESO

- 1 Cassettone L96,8
- 1 Fianco tamponamento laccato L2,2

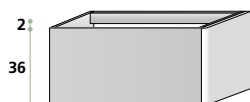

42	FL/PL36.9642	550	660
50	FL/PL36.9650	580	680

FIANCO AGGIUNTIVO

H36 L2,2

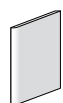

42	FL/FT036.42	SOLO LACCATO	50
50	FL/FT036.50	SOLO LACCATO	57



**MANIGLIA PORTA SALVIETTE
 PER FRONTALE CASSETTO**
 (misura minima frontale L61,6)
ALLUMINIO BRILL

FL/MA55	40
---------	----

PORTALAVABI

L28,6

BASE SOSPESA DX | SX

1 Anta L26,4

1 Fianco tamponamento laccato L2,2

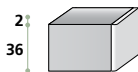

33	FL/BA36.02633
42	FL/BA36.02642
50	FL/BA36.02650

FLOW	
frontale ecowood	frontale laccato o essenza rovere tinto

200	240
240	280
260	300

BASE SOSPESA

1 Cassettone L26,4

1 Fianco tamponamento laccato L2,2



33	FL/BC36.02633
42	FL/BC36.02642
50	FL/BC36.02650

270	310
300	360
340	400

L37,4

BASE SOSPESA DX | SX

1 Anta L35,2

1 Fianco tamponamento laccato L2,2

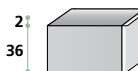

33	FL/BA36.03533
42	FL/BA36.03542
50	FL/BA36.03550

220	260
260	300
280	320

BASE SOSPESA

1 Cassettone L35,2

1 Fianco tamponamento laccato L2,2

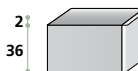

33	FL/BC36.03533
42	FL/BC36.03542
50	FL/BC36.03550

300	340
330	390
370	430

L55

BASE SOSPESA DX | SX

2 Ante L26,4

1 Fianco tamponamento laccato L2,2



33	FL/BA36.05233
42	FL/BA36.05242
50	FL/BA36.05250

260	330
310	380
330	400

BASE SOSPESA

1 Cassettone L52,8

1 Fianco tamponamento laccato L2,2



33	FL/BC36.05233
42	FL/BC36.05242
50	FL/BC36.05250

330	390
380	450
410	480

L63,8

BASE SOSPESA

1 Cassettoni L61,6
 1 Fianco tamponamento laccato L2,2

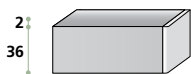

33	FL/BC36.06133
42	FL/BC36.06142
50	FL/BC36.06150

FLOW

frontale ecowood frontale laccato o essenza rovere tinto

350	420
400	480
440	520

L72,6

BASE SOSPESA

2 Ante L35,2
 1 Fianco tamponamento laccato L2,2



33	FL/BA36.07033
42	FL/BA36.07042
50	FL/BA36.07050

300	380
360	440
380	460

BASE SOSPESA

1 Cassettoni L70,4
 1 Fianco tamponamento laccato L2,2



33	FL/BC36.07033
42	FL/BC36.07042
50	FL/BC36.07050

370	450
430	510
460	540

L90,2

BASE SOSPESA

1 Cassettoni L88
 1 Fianco tamponamento laccato L2,2

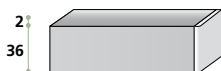

33	FL/BC36.08833
42	FL/BC36.08842
50	FL/BC36.08850

410	510
470	570
500	600

L99

BASE SOSPESA

1 Cassettoni L96,8
 1 Fianco tamponamento laccato L2,2

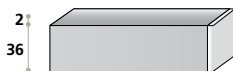

33	FL/BC36.09633
42	FL/BC36.09642
50	FL/BC36.09650

440	540
500	600
530	630

FIANCO AGGIUNTIVO

H36 L2,2



33	FL/FT036.33	SOLO LACCATO	40
42	FL/FT036.42	SOLO LACCATO	50
50	FL/FT036.50	SOLO LACCATO	57

BASI

L35,2

BASE A GIORNO

1 Vano a giorno

NO LACCATO LUCIDO

laccato
biancolaccato
colorato

PROF CODICE

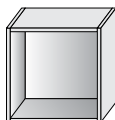

PROF	CODICE	laccato bianco	laccato colorato
33	FL/BG036.03533	270	310
42	FL/BG036.03542	330	370
50	FL/BG036.03550	390	440

BASE RACCORDO A GIORNO

1 Vano a giorno

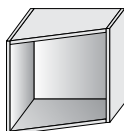

PROF	CODICE	laccato bianco	laccato colorato
42 33	FL/BGR36.04233	320	360
50 33	FL/BGR36.05033	370	410

L72

PENSILE A GIORNO
H16

PROF CODICE

NO LACCATO LUCIDO

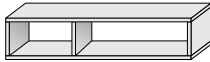
laccato
biancolaccato
colorato

16

SL/PG16072

180

200

L88

PENSILE A GIORNO
H16



16

SL/PG16088

210

240

L16

PENSILE A GIORNO
H72

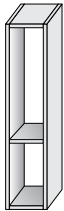

16

SL/PG72016

180

200

PENSILE A GIORNO
H88

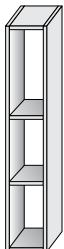

16

SL/PG88016

210

240

L28,6

COLONNA SOSPESA DX | SX
 1 Anta L26,4
 1 Fianco tamponamento laccato L2,2
 3 Ripiani



PROF CODICE

FLOW

ecowood laccato
 essenza rovere tinto

PROF	CODICE	ecowood	laccato essenza rovere tinto
20	FL/CA161.02620	450	570
33	FL/CA161.02633	580	700

L37,4

COLONNA SOSPESA DX | SX
 1 Anta L35,2
 1 Fianco tamponamento laccato L2,2
 3 Ripiani

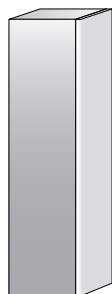

20	FL/CA161.03520	490	640
33	FL/CA161.03533	620	780

FIANCO AGGIUNTIVO
 H161,6 L2,2



20	FL/FT161.20	SOLO LACCATO	105
33	FL/FT161.33	SOLO LACCATO	155

L26,4

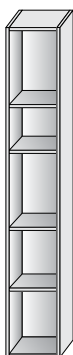
COLONNA SOSPESA
5 Vani a giorno

PROF CODICE

NO LACCATO LUCIDO

laccato
biancolaccato
colorato

PROF	CODICE	laccato bianco	laccato colorato
20	SL/CG02620	490	550
33	SL/CG02633	780	880

L35,2

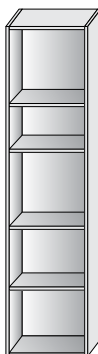
COLONNA SOSPESA
5 Vani a giorno

PROF	CODICE	laccato bianco	laccato colorato
20	SL/CG03520	540	610
33	SL/CG03533	870	960

L26,4

COLONNA A TERRA DX | SX

(oppure per piedini H10)

1 Anta vetro telaio alluminio

5 Ripiani

1 Ripiano legno

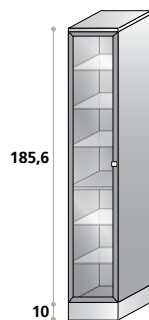

PROF CODICE

IN ELIMINAZIONE

20 CAST2620

33 CAST2633

ELEMENTI CON ANTA VETRO | TELAIO ALLUMINIO**FINITURA SCOCCA**

bianco opaco e lucido	colore opaco	colore lucido	essenza rovere tinto
c 12	c 20	c 29	c 66

450	450	450	450
500	500	500	500

L35,2

COLONNA A TERRA DX | SX

(oppure per piedini H10)

1 Anta vetro telaio alluminio

5 Ripiani

1 Ripiano legno

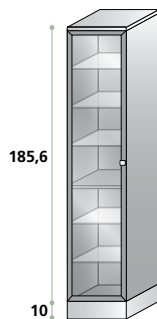

IN ELIMINAZIONE

20 CAST3520

33 CAST3533

500	500	500	500
550	550	550	550

COLONNA A TERRA DX | SX

(oppure per piedini H10)

2 Ante vetro telaio alluminio

5 Ripiani

1 Ripiano legno

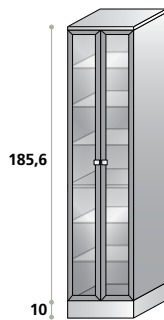

IN ELIMINAZIONE

20 CAST3520/2A

33 CAST3533/2A

600	600	600	600
650	650	650	650

L52,8

COLONNA A TERRA

(oppure per piedini H10)

1 Anta vetro telaio alluminio

5 Ripiani

1 Ripiano legno

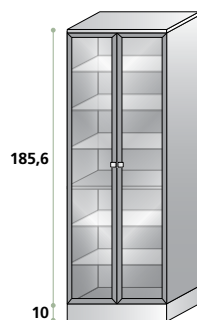

IN ELIMINAZIONE

20 CAST5220

33 CAST5233

700	700	700	700
770	770	770	770

H48

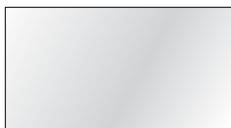

ILLUMINAZIONE

ABBINABILE

W

LARGHEZZA

CODICE

PREZZO

ABBINABILE	W	LARGHEZZA	CODICE	PREZZO
• Slice		52,8	SPESY48052/OR	137
• Silk		61,6	SPESY48061/OR	142
• Plate		70,4	SPESY48070/OR	144
• Tais		88	SPESY48088/OR	152
• Sofy		96,8	SPESY48096/OR	170
• Class		105,6	SPESY48105/OR	188
• Chiara		114,4	SPESY48114/OR	197
• Dionisio		123,2	SPESY48123/OR	212
▲ • Darix		132	SPESY48132/OR	218
▲ • Tais LL		140,8	SPESY48140/OR	225
▲ • Kolia				

• Con presa ed interruttore DX | SX

SPECCHI **EASY** FILO LUCIDO CON LED

H48

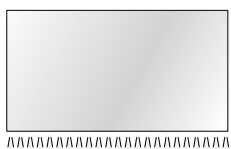

ABBINABILE	W	LARGHEZZA	CODICE	PREZZO
• Slice	2,9	61,6	SPESY48061/4L	217
• Silk	3,4	70,4	SPESY48070/4L	229
• Plate	4,2	88	SPESY48088/4L	257
• Tais	4,6	96,8	SPESY48096/6L	286
• Sofy	5	105,6	SPESY48105/6L	315
• Class	5,5	114,4	SPESY48114/6L	335
• Chiara	5,9	123,2	SPESY48123/6L	361
• Dionisio	6,3	132,8	SPESY48132/8L	376
▲ • Darix	6,7	140,8	SPESY48140/8L	395
▲ • Tais LL				
▲ • Kolia				

• Con led di cortesia
• Con interruttore per led
• Con presa ed interruttore DX | SX

SPECCHI **EASY** FILO LUCIDO

ILLUMINAZIONE vedi pag 235



SPECCHI

H64

ILLUMINAZIONE
 ABBINABILE W LARGHEZZA CODICE PREZZO



- Slice
- Silk
- Plate
- Tais
- Sofy
- Class
- Chiara
- Dionisio
- ▲ • Darix
- ▲ • Tais LL
- ▲ • Kolia

52,8	SPESY64052/OR	149
61,6	SPESY64061/OR	154
70,4	SPESY64070/OR	158
88	SPESY64088/OR	168
96,8	SPESY64096/OR	188
105,6	SPESY64105/OR	208
114,4	SPESY64114/OR	218
123,2	SPESY64123/OR	233
132	SPESY64132/OR	238
140,8	SPESY64140/OR	242

• Con presa ed interruttore DX | SX

SPECCHI **EASY** FILO LUCIDO CON LED



H64

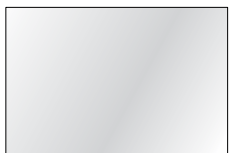

AAAAAAAAAAAAAAAAAAAAAAAAAAAA

- Slice
- Silk
- Plate
- Tais
- Sofy
- Class
- Chiara
- Dionisio
- ▲ • Darix
- ▲ • Tais LL
- ▲ • Kolia

2,9	61,6	SPESY64061/4L	229
3,4	70,4	SPESY64070/4L	243
4,2	88	SPESY64088/4L	273
4,6	96,8	SPESY64096/6L	304
5	105,6	SPESY64105/6L	335
5,5	114,4	SPESY64114/6L	356
5,9	123,2	SPESY64123/6L	382
6,3	132,8	SPESY64132/8L	396
6,7	140,8	SPESY64140/8L	412

• Con led di cortesia
 • Con interruttore per led
 • Con presa ed interruttore DX | SX

▲ Abbinabile a specchi di lunghezza minima 76 cm • Specificare nell'ordine posizione presa/interruttore (DX | SX) • Predisposizione per lampada non variabile

H64

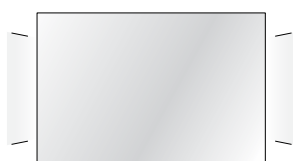

- Con due neon laterali
- Senza presa/interruttore

ILLUMINAZIONE
ABBINABILE W LARGHEZZA CODICE PREZZO

• Slice	61,6	SPESY2N64061	294
• Silk	70,4	SPESY2N64070	298
• Plate	88	SPESY2N64088	308
• Tais	96,8	SPESY2N64096	328
• Sofy	105,6	SPESY2N64105	348
• Class	114,4	SPESY2N64114	358
• Chiara	123,2	SPESY2N64123	373
• Dionisio	132	SPESY2N64132	378
▲ • Darix	140,8	SPESY2N64140	382
▲ • Tais LL			
▲ • Kolia			

SPECCHI **EASY** FILO LUCIDO
CON NEON E LED

H64

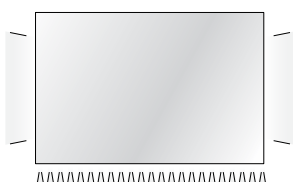

- Con due neon laterali e led di cortesia
- Con interruttore per led
- Senza presa/interruttore

• Slice	2,9	61,6	SPESY2N64061/4L	369
• Silk	3,4	70,4	SPESY2N64070/4L	383
• Plate	4,2	88	SPESY2N64088/4L	413
• Tais	4,6	96,8	SPESY2N64096/6L	444
• Sofy	5	105,6	SPESY2N64105/6L	475
• Class	5,5	114,4	SPESY2N64114/6L	496
• Chiara	5,9	123,2	SPESY2N64123/6L	522
• Dionisio	6,3	132,8	SPESY2N64132/8L	536
▲ • Darix	6,7	140,8	SPESY2N64140/8L	552
▲ • Tais LL				
▲ • Kolia				

H61,6



• Con presa ed interruttore DX | SX

ILLUMINAZIONE
ABBINABILE

LARGHEZZA

CODICE

PREZZO

- Slice
- Silk
- Plate
- Tais
- Sofy
- Class
- Chiara
- Dionisio

- ⚠ • Darix
- ⚠ • Tais LL
- ⚠ • Kolia

48

SPESY61048/VE

150

H70,4



• Con presa ed interruttore DX | SX

- Slice
- Silk
- Plate
- Tais
- Sofy
- Class
- Chiara
- Dionisio

- ⚠ • Darix
- ⚠ • Tais LL
- ⚠ • Kolia

48

SPESY70048/VE

152

64

SPESY70064/VE

162

H88



• Con presa ed interruttore DX | SX

- Slice
- Silk
- Plate
- Tais
- Sofy
- Class
- Chiara
- Dionisio

- ⚠ • Darix
- ⚠ • Tais LL
- ⚠ • Kolia

48

SPESY88048/VE

162

64

SPESY88064/VE

178

H96,8



• Con presa ed interruttore DX | SX

- Slice
- Silk
- Plate
- Tais
- Sofy
- Class
- Chiara
- Dionisio

- ⚠ • Darix
- ⚠ • Tais LL
- ⚠ • Kolia

48

SPESY96048/VE

180

64

SPESY96064/VE

198

H88

ILLUMINAZIONE

ABBINABILE

W

LARGHEZZA

CODICE

PREZZO

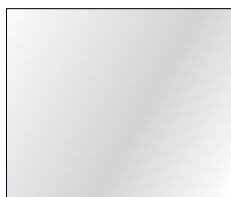

- Slice
- Silk
- Plate
- Tais
- Sofy
- Class
- Chiara
- Dionisio
- ▲ • Darix
- ▲ • Tais LL
- ▲ • Kolia

	70,4	SPESY88070/OR	178
	88	SPESY88088/OR	198
	96,8	SPESY88096/OR	212
	105,6	SPESY88105/OR	237
	114,4	SPESY88114/OR	245
	123,2	SPESY88123/OR	263
	132	SPESY88132/OR	269
	140,8	SPESY88140/OR	275

- Con presa ed interruttore DX | SX

SPECCHI **EASY** FILO LUCIDO CON LED

H88



- Slice
- Silk
- Plate
- Tais
- Sofy
- Class
- Chiara
- Dionisio
- ▲ • Darix
- ▲ • Tais LL
- ▲ • Kolia

3,4	70,4	SPESY88070/4L	263
4,2	88	SPESY88088/4L	303
4,6	96,8	SPESY88096/6L	328
5	105,6	SPESY88105/6L	364
5,5	114,4	SPESY88114/6L	383
5,9	123,2	SPESY88123/6L	412
6,3	132,8	SPESY88132/8L	427
6,7	140,8	SPESY88140/8L	445

- Con led di cortesia
- Con interruttore per led
- Con presa ed interruttore DX | SX

H88

ILLUMINAZIONE
ABBINABILE W LARGHEZZA CODICE PREZZO

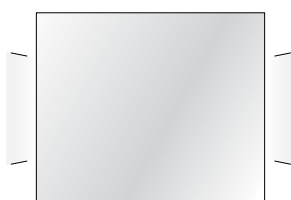

- Con due neon laterali
- Senza presa/interruttore

- Slice
- Silk
- Plate
- Tais
- Sofy
- Class
- Chiara
- Dionisio
- ▲ Darix
- ▲ Tais LL
- ▲ Kolia

70,4	SPESY2N88070	318
88	SPESY2N88088	338
96,8	SPESY2N88096	352
105,6	SPESY2N88105	377
114,4	SPESY2N88114	385
123,2	SPESY2N88123	403
132	SPESY2N88132	409
140,8	SPESY2N88140	415

SPECCHI **EASY** FILO LUCIDO
CON NEON E LED

H88

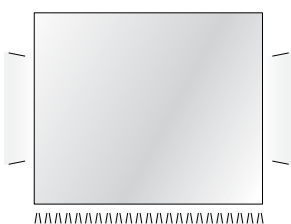

- Con due neon laterali e led di cortesia
- Con interruttore per led
- Senza presa/interruttore

- Slice
- Silk
- Plate
- Tais
- Sofy
- Class
- Chiara
- Dionisio
- ▲ Darix
- ▲ Tais LL
- ▲ Kolia

3,4	70,4	SPESY2N88070/4L	403
4,2	88	SPESY2N88088/4L	443
4,6	96,8	SPESY2N88096/6L	468
5	105,6	SPESY2N88105/6L	504
5,5	114,4	SPESY2N88114/6L	523
5,9	123,2	SPESY2N88123/6L	552
6,3	132,8	SPESY2N88132/8L	567
6,7	140,8	SPESY2N88140/8L	585

ILLUMINAZIONE
 ABBINABILE ALTEZZA CODICE PREZZO AL CML

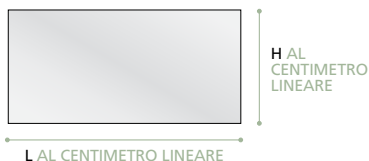

• Con presa ed interruttore DX | SX

- Slice
- Silk
- Plate
- Tais
- Sofy
- Class
- Chiara
- Dionisio
- ▲ Darix
- ▲ Tais LL
- ▲ Kolia

H fino a 60	SPDAYSM/H060	3,00
H da 61 a 72	SPDAYSM/H072	3,20
H da 73 a 93	SPDAYSM/H093	3,50
H da 94 a 105,5	SPDAYSM/H105	4,50

MAGGIORAZIONI PREZZO PER SPECCHI
SU MISURA

COPPIA NEON LATERALI **MAGG/2NEON** 140

CABLAGGIO CON LED (per lato inferiore specchi) **MAGG/LED** 1,20 cml
 numero 60 LED/MTL - 4,8 W/MTL

NOTE PER LA CORRETTA INSTALLAZIONE DEGLI SPECCHI

Traversi di fissaggio solo per lampade

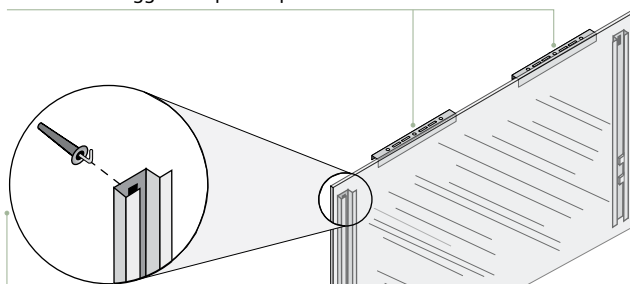

Fissare a muro lo specchio
 agganciando le asole dei
 montanti agli appositi
 ganci dei tasselli

▲ ATTENZIONE

Togliere le protezioni dallo specchio
 solo dopo aver ultimato l'installazione
 delle lampade e dei tasselli a muro

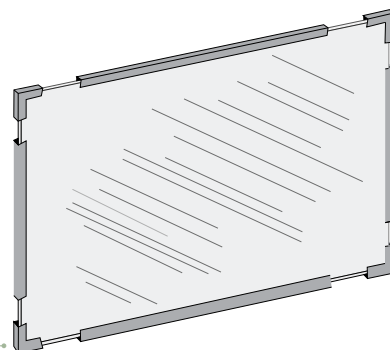

H72

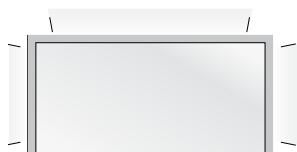

- Specchio con tre lati sabbiati
- Retroilluminato con tre neon
- Senza presa/interruttore

ILLUMINAZIONE ABBINABILE	LARGHEZZA	CODICE	PREZZO
	88	SPX3N72088/UP	376
	123,2	SPX3N72123/UP	472
	140,8	SPX3N72140/UP	508

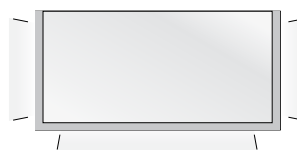

- Specchio con tre lati sabbiati
- Retroilluminato con tre neon
- Senza presa/interruttore

- Slice
- Silk
- Plate
- Tais
- Sofy
- Class
- Chiara
- Dionisio
- ▲ • Darix
- ▲ • Tais LL
- ▲ • Kolia

	88	SPX3N72088/DW	376
	123,2	SPX3N60123/DW	472
	140,8	SPX3N60140/DW	508

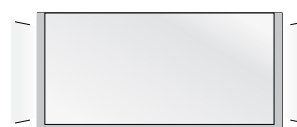

- Specchio con tre lati sabbiati
- Retroilluminato con due neon laterali
- Senza presa/interruttore

- Slice
- Silk
- Plate
- Tais
- Sofy
- Class
- Chiara
- Dionisio
- ▲ • Darix
- ▲ • Tais LL
- ▲ • Kolia

	88	SPX2N72088/DW	314
	123,2	SPX2N72123/DW	424
	140,8	SPX2N72140/DW	476

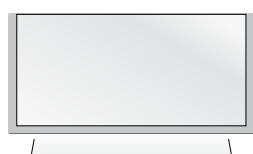

- Specchio con tre lati sabbiati
- Retroilluminato con un neon in basso
- Senza presa/interruttore

- Slice
- Silk
- Plate
- Tais
- Sofy
- Class
- Chiara
- Dionisio
- ▲ • Darix
- ▲ • Tais LL
- ▲ • Kolia

	88	SPX1N72088/DW	279
	123,2	SPX1N72123/DW	375
	140,8	SPX1N72140/DW	410

H72

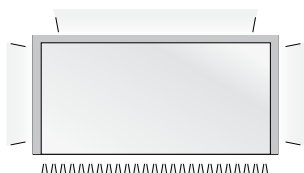

- Specchio con tre lati sabbati
- Retroilluminato con tre neon e led di cortesia
- Con interruttore per led
- Senza presa/interruttore

W	LARGHEZZA	CODICE	PREZZO
4,2	88	SPX3N72088/4L	484
5,9	123,2	SPX3N72123/6L	621
6,7	140,8	SPX3N72140/8L	678

H110,4

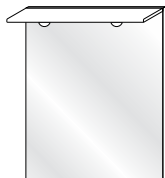

Faretti alogeni



- Incasso cromo
- Saturno

NUMERO FARETTI	LARGHEZZA	CODICE	bianco opaco c 10	bianco lucido c 12	colore opaco c 20	colore lucido c 29	ciliegio c 63	rovere c 65
2	70,4	SPA070AL	284	305	320	330	284	
3	88	SPA088AL	373	385	405	418	373	
3	96,8	SPA096AL	381	396	414	427	381	
4	105,6	SPA105AL	390	406	427	440	390	
4	114,4	SPA114AL	409	445	463	477	409	
5	123,2	SPA123AL	435	485	508	524	435	
5	132	SPA132AL	457	493	518	534	457	
5	140,8	SPA140AL	487	507	479	493	487	

SPECCHI **SOSPESI** P13,5
CON MENSOLA

H72

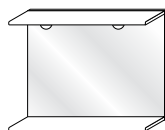

Faretti alogeni



- Incasso cromo
- Saturno

2	70,4	SPB070AL	256	280	294	304	256	
3	88	SPB088AL	373	385	404	417	373	
3	96,8	SPB096AL	381	396	414	427	381	
4	105,6	SPB105AL	390	406	427	440	390	
4	114,4	SPB114AL	409	445	463	477	409	
5	123,2	SPB123AL	435	485	508	524	435	
5	132	SPB132AL	457	493	518	534	457	
5	140,8	SPB140AL	487	507	532	549	487	

H110,4

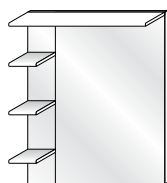

17,6

Faretti alogeni



- Incasso cromo
- Saturno
- Mensole 17,6 cm DX | SX

NUMERO FARETTI	LARGHEZZA	CODICE	bianco opaco c 10	bianco lucido c 12	colore opaco c 20	colore lucido c 29	ciliegio c 63	rovere c 65
-------------------	-----------	--------	-------------------------	--------------------------	-------------------------	--------------------------	------------------	----------------

3	88	SPM17088AL	396	426	446	459	396
4	105,6	SPM17105AL	420	446	468	483	420

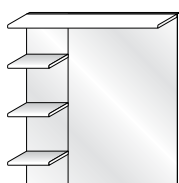

26,4

Faretti alogeni



- Incasso cromo
- Saturno
- Mensole 26,4 cm DX | SX

3	96,8	SPM26096AL	409	436	457	471	409
4	114,4	SPM26114AL	448	486	508	524	448
5	123,2	SPM26123AL	484	525	552	569	484
5	132	SPM26132AL	499	542	573	591	499

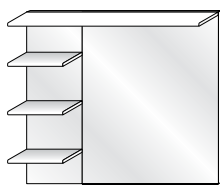

35,2

Faretti alogeni



- Incasso cromo
- Saturno
- Mensole 35,2 cm DX | SX

4	105,6	SPM35105AL	420	446	468	483	420
5	123,2	SPM35123AL	484	525	552	569	484
5	132	SPM35132AL	499	542	573	591	499
5	140,8	SPM35140AL	521	567	594	612	521

SILK IN SOLID SURFACE
FINITURA BIANCO SATINATO

P9 H1,2

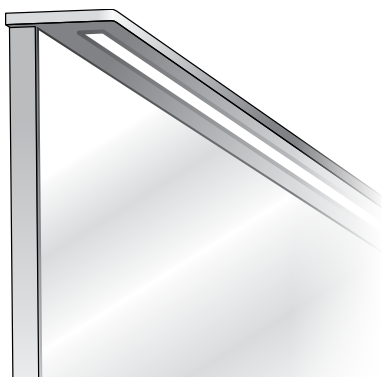
LAMPADA SILK SU MISURA
PREZZO AL CENTIMETRO LINEARE

W	LUNGHEZZA	CODICE	PREZZO
4,1	48,7	FL/FAR050	124
5,6	64,7	FL/FAR060	140
6,3	71,1	FL/FAR070	165
8	88,7	FL/FAR080	185
8,7	97,5	FL/FAR090	205
9,6	106,3	FL/FAR100	216
10,5	115,1	FL/FAR110	238
11,3	123,9	FL/FAR120	248
12,3	132,7	FL/FAR130	270
13	141,5	FL/FAR140	280
9,6	CML	FL/FAR.SM	2,50

SLICE IN MULTISTRATI H4
TUTTE LE FINITURE

P9 H4

LAMPADA SLICE SU MISURA
PREZZO AL CENTIMETRO LINEARE

2,7	35,2	SL/FAR035	125
4,4	52,8	SL/FAR052	165
5,3	61,6	SL/FAR061	186
6	70,4	SL/FAR070	210
7,7	88	SL/FAR088	235
8,7	96,8	SL/FAR096	250
9,6	105,6	SL/FAR105	265
10,3	114,4	SL/FAR114	280
11,3	123,2	SL/FAR123	300
12	132	SL/FAR132	320
13	140,8	SL/FAR140	340
13,7	149,6	SL/FAR149	360
9,6	CML	SL/FAR.SM	3

ILLUMINAZIONE LED

PROF
DA MURO CODICE PREZZO



TAIS A LED
1x4,8W LED 220V
CON ALIMENTATORE

FINITURA CROMO

L30 P10 H4

10

FAR/TAIS/L

99



TAIS A LED LUNGA
1x9,6W LED 220V
CON ALIMENTATORE

FINITURA CROMO

L56 P10 H4

14

FAR/TAIS/LL

125

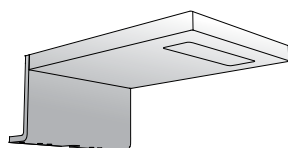

PLATE ATTACCO A TELAIO
1x7W LED 220V
CON ALIMENTATORE

FINITURA CROMO

L10 P14,3 H6

16,5

FAR/PLATE/05

170

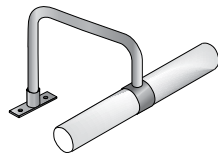

CHIARA ATTACCO A TELAIO
2x40W alogeno 220V

FINITURA CROMO

L24,5 P11,5 H14,5

PROF
DA MURO CODICE PREZZO

12

FAR/CHIARA/05

145

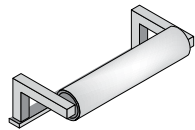

SOFY ATTACCO A TELAIO
1x80W alogeno 220V

FINITURA CROMO

L18,5 P8,5 H6,5

9

FAR/SOFY/05

145

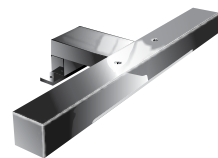

TAIS ATTACCO A TELAIO
1x60W alogeno 220V

FINITURA CROMO

L30 P10 H4

10

FAR/TAIS

89

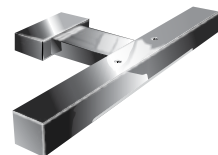

TAIS ATTACCO A MURO
1x60W alogeno 220V

FINITURA CROMO

L30 P14 H4

14

FAR/TAIS/W

132

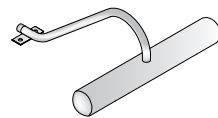

DIONISIO ATTACCO A TELAIO
1x80W alogeno 220V

FINITURA CROMO

L22,5 P22 H7,5

22

FAR/DIONISIO/05

96

SOVRACOLONNE PER COLONNE H116

SPECCHI FILO LUCIDO

SU MISURA
PIÙ
30%

245

H76,5

LARGHEZZA CODICE

bianco opaco c 10 bianco lucido c 12 colore opaco c 20 colore lucido c 29 ciliegio c 63 rovere c 65

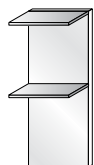

- 1 mensola
- 1 tettino

LARGHEZZA	CODICE	bianco opaco c 10	bianco lucido c 12	colore opaco c 20	colore lucido c 29	ciliegio c 63	rovere c 65
26,4	SVL026	77	96	116	120	80	
35,2	SVL035	87	102	122	127	97	
52,8	SVL052	126	132	165	170	130	
70,4	SVL070	154	163	181	187	161	

INTERPENSILI

SOVRACOLONNE PER COLONNE H123,8

SPECCHI FILO LUCIDO

SU MISURA
PIÙ
30%

H68,5

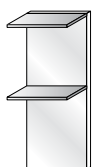

- 1 mensola
- 1 tettino

LARGHEZZA	CODICE	bianco opaco c 10	bianco lucido c 12	colore opaco c 20	colore lucido c 29	ciliegio c 63	rovere c 65
26,4	SVLH026	77	96	116	120	80	
35,2	SVLH035	87	102	122	127	97	
52,8	SVLH052	126	132	165	170	130	
70,4	SVLH070	154	163	181	187	161	

P12

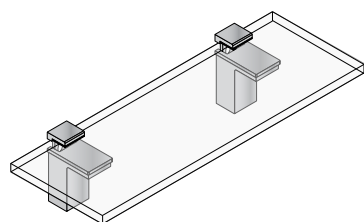

- Compreso reggimensole QUADRA finitura cromo o alluminio

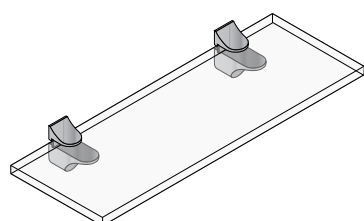

- Compreso reggimensole TUCANINO finitura cromo o alluminio

LARGHEZZA	CODICE	vetro trasp.	laccato opaco cod 20	laccato lucido cod 29	essenza rovere tinto cod 84
26,4	MEVETR/026	53			
35,2	MEVETR/035	55			
52,8	MEVETR/052	56			
70,4	MEVETR/070	59			
88	MEVETR/088	61			
96,8	MEVETR/096	64			
105,6	MEVETR/105	68			
114,2	MEVETR/114	72			
123,2	MEVETR/123	75			
132	MEVETR/132	78			
140,8	MEVETR/140	81			
158,4	MEVETR/158	95			
167,2	MEVETR/167	102			
176	MEVETR/176	111			

MENSOLE MULTISTRATO H4

P13

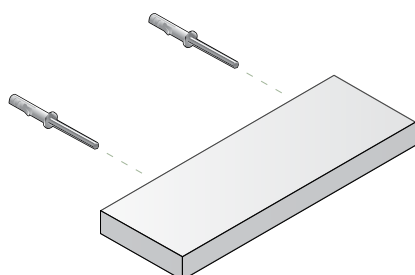

- Compreso reggimensole a scomparsa
- Foro su muro Ø 12

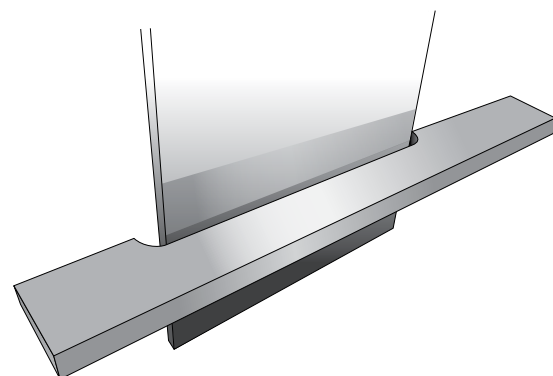

LAVORAZIONE ASOLA SU MENSOLE SP4 cm
PER ALLOGGIO SPECCHI:
EASY L48 - L64 | TOWER L70 - L140

MAGG/ASOLA.ME4 euro 75

26,4	ME40026	50	56	59
35,2	ME40035	57	63	68
52,8	ME40052	77	88	95
61,6	ME40061	87	100	108
70,4	ME40070	98	112	120
88	ME40088	110	127	139
96,8	ME40096	116	132	146
105,6	ME40105	124	140	157
114,2	ME40114	139	156	173
123,2	ME40123	148	167	186
132	ME40132	157	177	197
140,8	ME40140	166	188	222
158,4	ME40158	182	207	232
167,2	ME40167	194	220	246
176	ME40176	203	230	257
184,8	ME40184	214	243	272
193,6	ME40193	222	252	283
202,4	ME40202	236	267	299
211,2	ME40211	252	285	318
220	ME40220	270	305	340

PIEDINI

H10

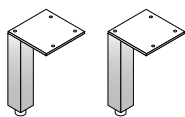

PIEDINI PLANAR
 Confezione **2** pezzi
 In alluminio
 Regolabili

CODICE

PREZZO

PIEDPLAN/H10/02 SATINATO

42

PIEDPLAN/H10/05 BRILLANTE

42

H17

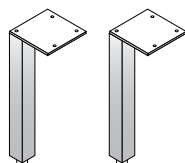

PIEDINI PLANAR
 Confezione **2** pezzi
 In alluminio
 Regolabili

PIEDPLAN/H17/02 SATINATO

60

PIEDPLAN/H17/05 BRILLANTE

60

H22

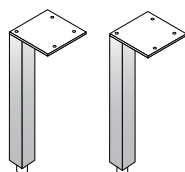

PIEDINI PLANAR
 Confezione **2** pezzi
 In alluminio
 Regolabili

PIEDPLAN/H22/02 SATINATO

66

PIEDPLAN/H22/05 BRILLANTE

66

H34

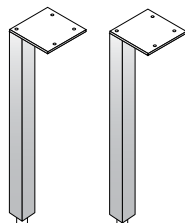

PIEDINI PLANAR
 Confezione **2** pezzi
 In alluminio
 Regolabili

PIEDPLAN/H34/02 SATINATO

85

PIEDPLAN/H34/05 BRILLANTE

85

RUOTE

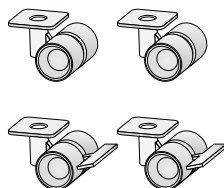

RUOTE FIVE
 Finitura grigio chiaro
 Confezione **4** pezzi
2 con freno
2 senza freno

V951

52

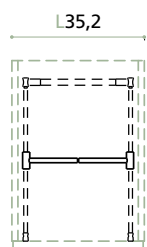

PER BASE L35,2

FINITURA	CODICE	PREZZO
----------	--------	--------

alluminio	V2/ORG035	30
-----------	-----------	----

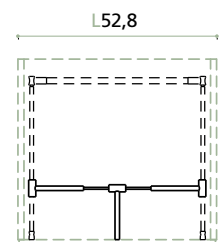

PER BASE L52,8

alluminio	V2/ORG052	60
-----------	-----------	----

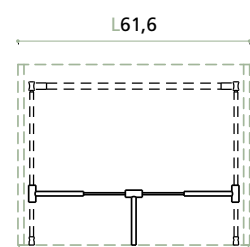

PER BASE L61,6

alluminio	V2/ORG061	72
-----------	-----------	----

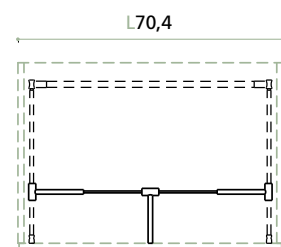

PER BASE L70,4

alluminio	V2/ORG070	96
-----------	-----------	----

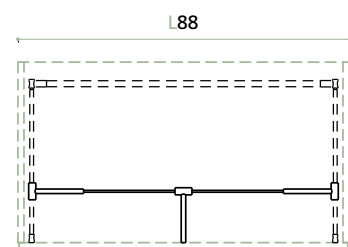

PER BASE L88

alluminio	V2/ORG088	96
-----------	-----------	----

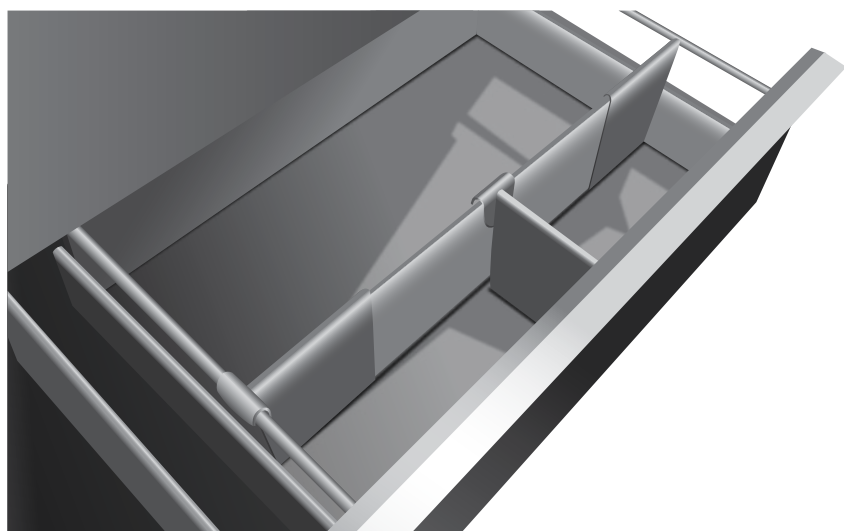

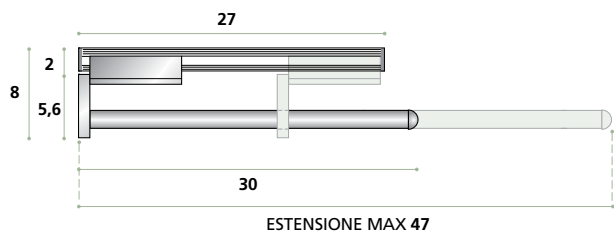

FINITURA CODICE PREZZO

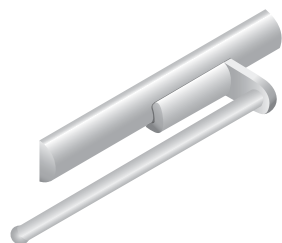

**PORTASALVIETTE
ESTRAIBILE**

Per fianco mobile DX - SX
IN ALLUMINIO

alluminio	V922/02	52
-----------	---------	----

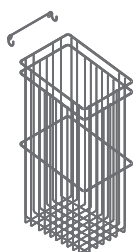

**CESTO
PORTABIANCHERIA
A RIBALTA**

Per base L 26,4
Asportabile

L20,5 H60 P29

	IN ELIMINAZIONE	
cromo	V2/035	105

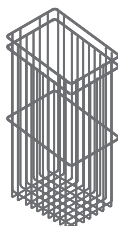

**CESTO
PORTABIANCHERIA
DA APPOGGIO**

Per base L 26,4

L20,5 H60 P29

	IN ELIMINAZIONE	
cromo	V2/036	101

FLOAT spessore 10 | 15 mm

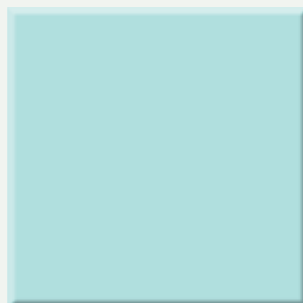

ACQUAMARINA

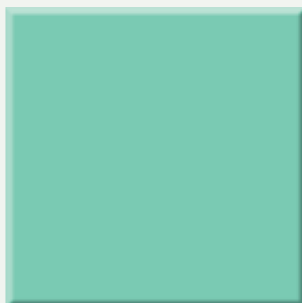

VERDE TWEED



TURCHESE



VERDE SMERALDO



CIELO



AZZURRO MALDIVE



AZZURRO CS



CELESTE METAL



BLU TOBAGO



BLU OCEANO



ROSSO CS



CUOIO

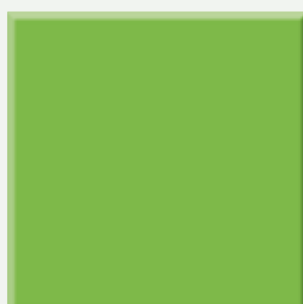

LIMONE

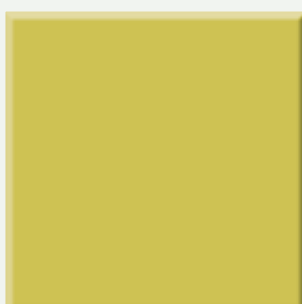

POMPELMO



GRIGIO CS



NERO



PURPLE



ARDESIA METAL

EXTRACHIARO spessore 10 | 15 mm

BIANCO LATTE



SABBIA



BEIGE CS



ROSA



ARGENTO METAL



ALLUMINIO METAL



ORO METAL



RAME METAL



GIALLO



ARANCIO



ROSSO VIVO



GLICINE

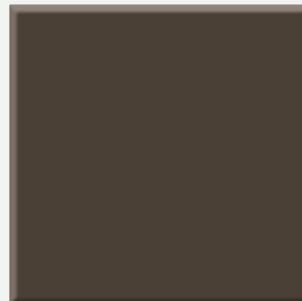

TORTORA



FUXIA

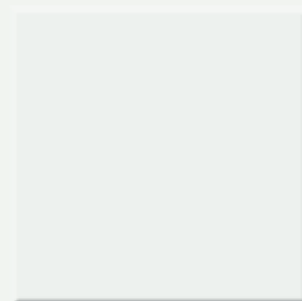

ALASKA | sp 19 mm

FLOAT spessore 10 | 15 mm

VERDE OASI



MIELE



CAMOSCIO

GAMMA COLORI **SPECIALI | TOP CRISTALLO** | campioni solo su richiesta**FLOAT** spessore 10 | 15 mm

ACQUAMARINA Metal

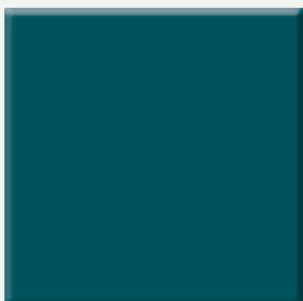

VERDE SHERWOOD



BLU BRILLANTE



BLU ARTICO



GIALLO INCAS



BRONZO



MANDORLA

GAMMA COLORI **TWIN | TOP CRISTALLO****EXTRACHIARO** spessore 10 | 15 mm

AVANA



GIALLO DUNA



VERDE MELA



AZZURRO ARTICO

GAMMA COLORI **SPECIALI | TOP CRISTALLO** | campioni solo su richiesta**EXTRACHIARO** spessore 10 | 15 mm

CORDA CS



ROSA CHIARO



GRIGIO CHIARO



VERDE GIOIA



BLU LUCE

CATEGORIA C1



CARRARA

Marmo

CATEGORIA C2



ROSA TOSCANA

Marmoresina

In eliminazione



BLU LAZIO

Marmoresina

In eliminazione



VERDE LIGURIA

Marmoresina

In eliminazione



BOTTICINO

Marmoresina



PERLINO ROSATO

Marmoresina



ROSSO ASIAGO

Marmoresina

CATEGORIA C3



BEIGE SAVANNAH

Marmoresina



RIGOLETTO

Marmoresina



GIALLO MAYA

Marmoresina



WHITE ICEBERG

Marmoresina



CARRARA TECNICO

Marmoresina



GIALLO REALE

Marmoresina

CATEGORIA C4



BIANCO POLARE

Marmoresina



CANALETTO

Marmoresina



GIALLO SOLE

Marmoresina



ROSA TURANDOT

Marmoresina



SAHARA GOLD

Marmo



TRAVERTINO STUCCATO

Marmo



PIETRA SERENA

Marmo

CATEGORIA C5



GIOTTO

Marmoresina



MOKA CREMA

Marmo



BIANCONE

Marmo

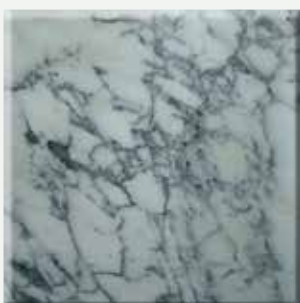

CALACATTA ARABESCATO

Marmo



ROSA PERLINO

Marmo

CATEGORIA C7

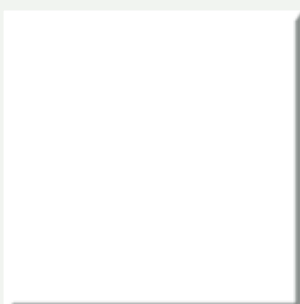

BIANCO OPALE

Vetro



EMPERADOR

Marmo



GRAFITE

Marmo



NERO T590

Quarzoresina

CATEGORIA C6



GRIS ANTRACITE

Quarzoresina



MARRON GLACÉ

Quarzoresina



CRISTALLINO NAXOS

Marmo



ROSA PORTOGALLO

Marmo



TRAVERTINO RESINATO

Marmo



TRAVERTINO NOCE

Marmo



BOTTICINO

Marmo



VERDE GUATEMALA

Marmo



NERO MARQUINIA

Marmo

CATEGORIA C8



WHITE

Quarzoresina



TURCOISE

Quarzoresina



GREEN

Quarzoresina



PINK

Quarzoresina

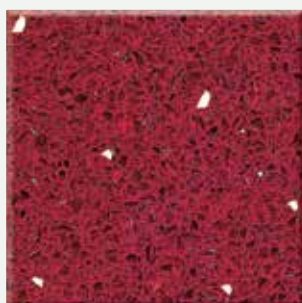

RUBY

Quarzoresina



GREY

Quarzoresina



BLUE

Quarzoresina

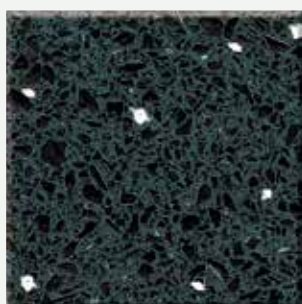

BLACK

Quarzoresina



MOKA

Quarzoresina



QUARZO BIANCO

Quarzoresina



QUARZO NOCE

Quarzoresina

CATEGORIA C9



SPACCO BIANCO

Quarzoresina



SPACCO BEIGE

Quarzoresina



SPACCO MARRONE

Quarzoresina



SPACCO GRIGIO

Quarzoresina



SPACCO NERO

Quarzoresina



NERO ASSOLUTO

Granito



NERO AFRICA

Granito



CALACATTA ORO

Marmo



PALISSANDRO

Marmo

CATEGORIA A1



BLANCO NORTE



GRIS EXPO



MARENGO

CATEGORIA A2



CEMENTO



TOFFE



WHITE STORM



ARDEN BLUE

CATEGORIA A3

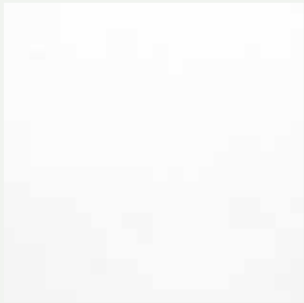

BLANCO ZEUS



KENSHO



DORADUS



UNSUI



HAIKU

PROF 33,4 - 42,3 - 50,4 per BASI STANDARD



VEDI MAGGIORAZIONE
LAVORAZIONI A
FONDO PAGINA



	Senza foro			Senza foro			Senza foro		Senza foro	
	LACCATO BIANCO OPACO/LUCIDO Sp 1,4			LACCATO COLORATO OPACO/LUCIDO Sp 1,4			LACCATO BIANCO OPACO/LUCIDO Sp 3		LACCATO COLORATO OPACO/LUCIDO Sp 3	
	P33,4	P42,3	P50,4	P33,4	P42,3	P50,4	P33,4	P50,4	P33,4	P50,4
LUNGHEZZA FINO A CM										
60,5 *	87	103	119	102	123	143	87	119	102	143
70,5	97	116	135	115	139	163	97	135	115	163
80,5	112	134	156	133	161	188	112	156	133	188
90,5	117	141	165	138	168	198	117	165	138	198
100,5	123	149	174	145	177	208	123	174	145	208
110,5	128	155	182	152	186	219	128	182	152	219
120,5	133	160	187	158	191	224	133	187	158	224
130,5	139	168	196	164	199	234	139	196	164	234
140,5	158	189	219	184	221	258	158	219	184	258
150,5	166	199	231	194	234	273	166	231	194	273
160,5	175	209	243	205	247	288	175	243	205	288
170,5	183	220	256	215	259	303	183	256	215	303
180,5	190	229	268	223	271	318	190	268	223	318
190,5	200	241	282	245	299	352	200	282	245	352
200,5	210	254	297	258	315	372	210	297	258	372
210,5	231	272	313	272	333	393	231	313	272	393
220,5	242	294	346	302	370	438	242	346	302	438

LAVORAZIONI AGGIUNTIVE

Maggiorazione foro scarico per lavabi appoggio compreso foro rubinetto	60
Maggiorazione asola per lavabi appoggio compreso foro rubinetto	60

PROF 33,4 - 50,4 per BASI STANDARD



VEDI MAGGIORAZIONE
LAVORAZIONI A
FONDO PAGINA



	LACCATO BIANCO OPACO/LUCIDO Sp 4		LACCATO COLORATO OPACO/LUCIDO Sp 4		ESSENZA ROVERE TINTO Sp 4		
	P33,4	P50,4	P33,4	P50,4	P33,4	P50,4	
LUNGHEZZA FINO A CM							
60,5 *	165	229	183	254	183	254	
70,5	202	278	224	309	224	309	
80,5	215	299	239	332	239	332	
90,5	235	324	261	360	261	360	
100,5	249	344	277	382	277	382	
110,5	264	361	293	401	293	401	
120,5	283	386	314	429	314	429	
130,5	297	407	330	452	330	452	
140,5	313	430	348	478	348	478	
150,5	336	460	373	511	373	511	
160,5	353	483	392	537	392	537	
170,5	368	508	409	564	409	564	
180,5	400	551	444	612	444	612	
190,5	419	579	465	643	465	643	
200,5	438	607	487	674	487	674	
210,5	469	646	521	718	521	718	
220,5	490	676	544	751	544	751	

LAVORAZIONI AGGIUNTIVE

Maggiorazione foro scarico per lavabi appoggio compreso foro rubinetto	60
Maggiorazione asola per lavabi appoggio compreso foro rubinetto	60

PROF 51 per BASI STANDARD - compreso un foro soprap/sottop/appoggio
PROF 55 massimo ordinabile - compreso un foro soprap/sottop/appoggio

ESEMPI APPLICATIVI

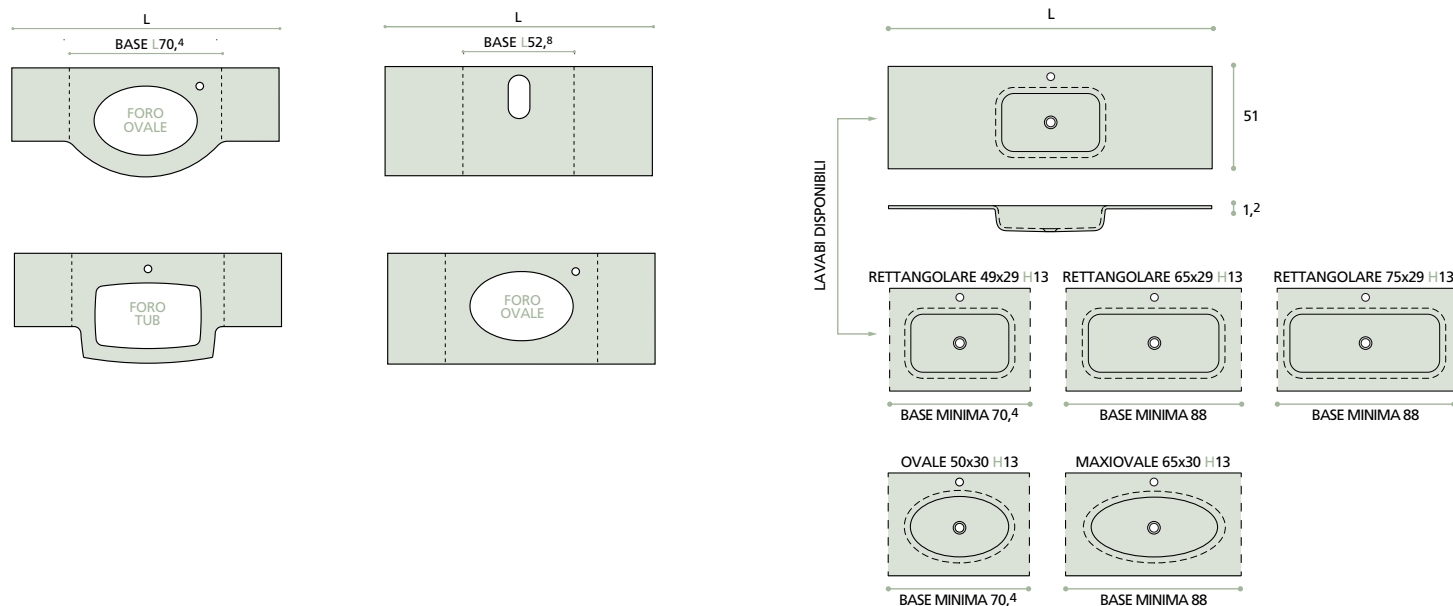

	LOAT + EX.CHIARO	FLOAT	EX.CHIARO	LOAT + EX.CHIARO	LOAT + EX.CHIARO	FLOAT	EX.CHIARO			
	Sp 1	Sp 1,5	Sp 1,5	Sp 1 - 1,5	Sp 1	Sp 1,5	Sp 1,5	1LAV	2LAV	
				ALZATINE	INTEGRATO	INTEGRATO	INTEGRATO	1LAV	2LAV	
LUNGHEZZA FINO A CM										
60,5 *	307	338	372	54						
70,5	347	383	423	63	687	723	763			
80,5	387	429	474	72	727	769	814			
90,5	428	474	525	81	768	814	865			
100,5	468	520	577	90	808	860	917			
110,5	509	565	628	99	849	905	968			
120,5	549	611	679	108	889	951	1019			
130,5	589	656	730	117	929	996	1070			
140,5	630	702	781	125	970	1570	1042	1642	1121	1721
150,5	670	747	832	134	1010	1610	1087	1687	1172	1772
160,5	711	793	884	143	1051	1651	1133	1733	1224	1824
170,5	751	838	935	152	1091	1691	1178	1778	1275	1875
180,5	791	884	986	161	1131	1731	1224	1824	1326	1926
190,5	832	930	1037	170	1172	1772	1270	1870	1377	1977
200,5	872	975	1088	179	1212	1812	1315	1915	1428	2028
210,5	913	1021	1139	188	1253	1853	1361	1961	1479	2079
220,5	953	1066	1190	197	1293	1893	1406	2006	1530	2130

LAVORAZIONI AGGIUNTIVE

Maggiorazione doppio foro lavabo compreso foro rubinetto	80	
Sabbiatura e trattamento anti-impronta	220	320
Colori a richiesta RAL (solo su vetro extrachiaro)	120	120

PROF **34** per BASI STANDARD - senza foro

PROF **43** massimo ordinabile - senza foro (basi modello FLOW P42,3)

ESEMPI APPLICATIVI

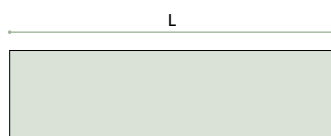

	FLOAT + EX.CHIARO Sp 1	FLOAT Sp 1,5	EX.CHIARO Sp 1,5	FLOAT + EX.CHIARO Sp 1 - 1,5			
LUNGHEZZA FINO A CM							
60,5 *	181	237	259	54			
70,5	211	276	301	63			
80,5	240	315	344	72			
90,5	270	354	386	81			
100,5	300	393	429	90			
110,5	329	432	471	99			
120,5	359	470	514	108			
130,5	389	509	556	117			
140,5	418	548	599	125			
150,5	448	587	641	134			
160,5	478	626	684	143			
170,5	507	665	726	152			
180,5	537	704	768	161			
190,5	567	743	811	170			
200,5	596	781	853	179			
210,5	626	820	896	188			
220,5	656	859	938	197			

LAVORAZIONI AGGIUNTIVE

Sabbiatura e trattamento anti-impronta	220
Colori a richiesta RAL (solo su vetro extrachiaro)	120

PROF 51 per BASI STANDARD - senza foro
PROF 51 massimo ordinabile - senza foro

ESEMPI APPLICATIVI

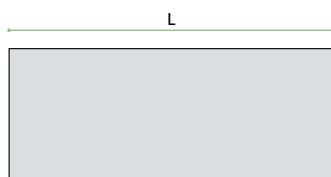

CATEGORIE	Spessore 2 cm						Spessore 2 cm				
	C1	C2	C3	C4	C5	Alzat.	C6	C7	C8	C9	Alzat.
LUNGHEZZA FINO A CM	vedi pag 352	vedi pag 352	vedi pag 352	vedi pag 352	vedi pag 352	Categorie C1-2-3-4-5	vedi pag 354	vedi pag 354	vedi pag 354	vedi pag 354	Categorie C6-7-8-9
60,5 *	130	149	165	208	226	31	295	313	347	365	44
70,5	152	174	192	243	263	36	344	364	404	424	51
80,5	173	198	219	277	300	41	392	415	461	484	59
90,5	194	223	246	311	337	46	440	466	518	544	66
100,5	216	247	273	345	374	51	489	518	575	604	73
110,5	237	272	300	379	411	56	537	569	632	664	80
120,5	258	296	327	413	448	61	586	620	689	723	87
130,5	280	321	354	447	485	66	634	671	746	783	95
140,5	301	345	381	482	522	71	682	722	803	843	102
150,5	322	370	408	516	559	76	731	774	860	903	109
160,5	344	394	435	550	596	81	779	825	917	962	116
170,5	365	419	462	584	633	86	828	876	974	1022	124
180,5	386	443	489	618	670	91	876	927	1030	1082	131
190,5	408	468	517	652	707	96	924	979	1087	1142	138
200,5	429	492	544	687	744	101	973	1030	1144	1202	145
210,5	450	517	571	721	781	106	1021	1081	1201	1261	153
220,5	472	541	598	755	818	111	1069	1132	1258	1321	160

LAVORAZIONI AGGIUNTIVE

Anticatura (spazzolato e cerato)	+ 15%
Spessore 3 cm (verificare disponibilità)	+ 30%

PROF 51 per BASI STANDARD - senza foro
 PROF 55 massimo ordinabile - senza foro

ESEMPI APPLICATIVI

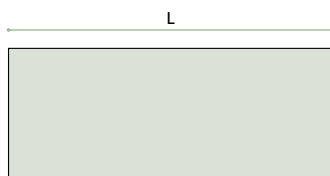

	FLOAT + EX.CHIARO Sp 1	FLOAT Sp 1,5	EX.CHIARO Sp 1,5	FLOAT + EX.CHIARO Sp 1 - 1,5			
LUNGHEZZA FINO A CM							
60,5 *	247	278	312	54			
70,5	287	323	363	63			
80,5	327	369	414	72			
90,5	368	414	465	81			
100,5	408	460	517	90			
110,5	449	505	568	99			
120,5	489	551	619	108			
130,5	529	596	670	117			
140,5	570	642	721	125			
150,5	610	687	772	134			
160,5	651	733	824	143			
170,5	691	778	875	152			
180,5	731	824	926	161			
190,5	772	870	977	170			
200,5	812	915	1028	179			
210,5	853	961	1079	188			
220,5	893	1006	1130	197			

LAVORAZIONI AGGIUNTIVE

Sabbatura e trattamento anti-impronta	220
Colori a richiesta RAL (solo su vetro extrachiaro)	120

CRISTALPLANT

È un materiale composto da idrati di alluminio e resine poliestere dalle alte prestazioni chimiche e meccaniche. Omogeneo ed uniforme in tutto lo spessore è compatto e resistente agli agenti chimici ed al graffio. Per la manutenzione quotidiana usare normali detergenti per la pulizia del bagno disponibili in commercio. Eventuali danneggiamenti possono essere rimossi mediante spugnetta abrasiva, rinnovando la superficie.

GEACRYL

È un composto solido di cariche minerali naturali (triidrato di alumina) e polimeri leganti di alta qualità. Il film di rivestimento della superficie consente di ottenere un'ottima resistenza chimico-fisica nel tempo. La lucentezza della superficie lo rende elegante, piacevole al tatto e molto simile al materiale ceramico. Il prodotto GEACRYL garantisce inoltre un'assoluta impermeabilità ed igiene nell'utilizzo quotidiano, è resistente alle sostanze chimiche usate per la pulizia, ha proprietà antibatteriche, di ininfiammabilità e autoestinguenza.

Per la manutenzione quotidiana basta usare acqua saponata o detergenti non abrasivi abbinati ad una spugna o panno di cotone. Eventuali graffi non profondi possono essere rimossi levigando con carta abrasiva finissima e lucidando con pasta tipo polish.

TECNORIL

È un materiale costituito per il 70% da minerale naturale combinato con resina acrilica di altissima qualità e non da resina poliestere. Questa composizione permette al colore del top di rimanere inalterato nel tempo. La superficie compatta e non porosa è facile da pulire, utilizzando acqua tiepida, un panno o una spugna morbidi e i più comuni prodotti per la pulizia domestica. Nel caso di macchie particolarmente persistenti o piccoli tagli e graffi, utilizzare un detergente abrasivo ed una spugnetta abrasiva.

MINERALMARMO

Realizzato per colata unica di resine rivestite da una finitura in gelcoat lucida. Per la manutenzione quotidiana basta usare acqua saponata o detergenti non abrasivi abbinati ad una spugna o panno di cotone. Eventuali graffi non profondi possono essere rimossi levigando con carta abrasiva finissima e lucidando con pasta tipo polish.

SOLID SURFACE DuPont™

Dupont Solid Surface è un materiale decorativo che può essere impiegato sia per utilizzi residenziali che commerciali quali alberghi, comunità, contract. Il Dupont Solid Surface è un materiale composito che viene prodotto per colata continua, con un processo produttivo rigoroso e controlli di qualità specifici e capillari.

Viene realizzato in lastre e può essere utilizzato per molteplici applicazioni: pannelli murali, piani tavolo, top da bagno e cucina, piani da lavoro per uffici o comunità, controsoffitti speciali, tamponamenti per docce, piani lavabo multipli per locali pubblici e molto altro.

Il Dupont Solid Surface è un materiale solido, massivo nella struttura e compatto. Le sue caratteristiche sono durabilità, uniformità della superficie, estrema tenuta agli agenti esterni, non porosità, antibatterico, igienico e dalla superficie rilevigabile in caso di necessità. Queste caratteristiche fanno del Dupont Solid Surface un materiale eccezionale ed adatto alle zone della casa con un utilizzo intenso (bagno, cucina, piani di lavoro etc.)

Il nostro nuovo materiale Dupont Solid Surface è quindi perfetto per la produzione di top, piani lavabo ed accessori. All'occorrenza può essere tagliato, levigato, giuntato in modo invisibile e inciso, in modo da creare una ampia gamma di progetti, motivi di design ed intarsi o effetti speciali. Quindi, ampia possibilità di progettazione per i vostri interni da arredare.

PROF 42,3 per modello FLOW | SLICE - senza kit di scarico troppo pieno
(mobile FLOW con sifone salva-spazio più piletta in dotazione)

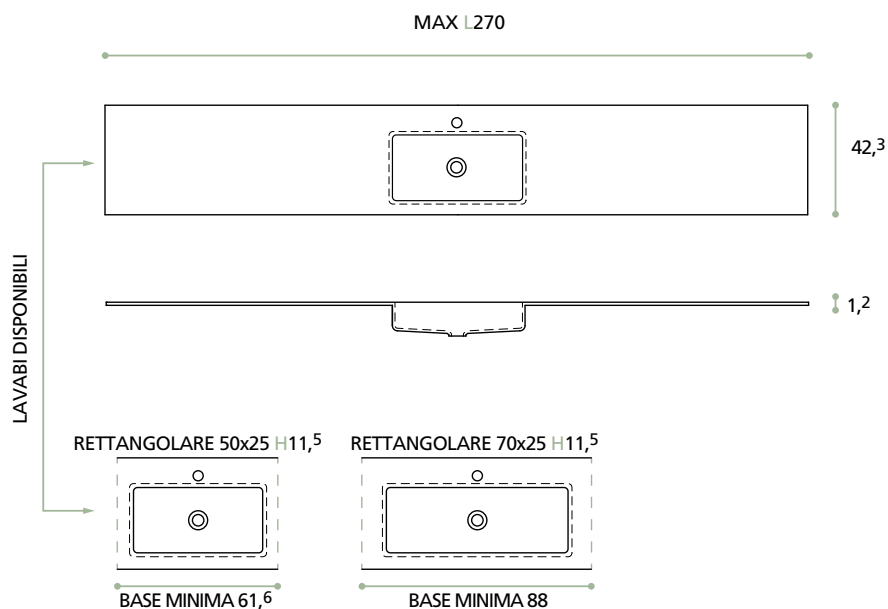

LUNGHEZZA FINO A CM	GEACRYL Sp 1,2		TECNORIL Sp 1,2	
	1LAVABO	2LAVABI	1LAVABO	2LAVABI
60,5 *	647		673	
70,5	687		713	
80,5	707		753	
90,5	728		793	
100,5	748		832	
110,5	768		872	
120,5	788	1577	912	1466
130,5	809	1618	951	1506
140,5	829	1658	991	1546
150,5	849	1698	1030	1585
160,5	869	1739	1070	1625
170,5	890	1779	1110	1665
180,5	910	1820	1149	1704
190,5	930	1860	1189	1744
200,5	950	1901	1229	1783
210,5	971	1941	1268	1823
220,5	991	1982	1308	1863

LAVORAZIONI AGGIUNTIVE

Fresata o asola per porta salviette (su una faccia) 120

ALZATINE spessore 12 mm

fino H10 1,30 cml
da H10,1 a H20 2,30 cml

PROF 50,3 per modello FLOW - senza kit di scarico troppo pieno
(mobile FLOW con sifone salva-spazio più piletta in dotazione)

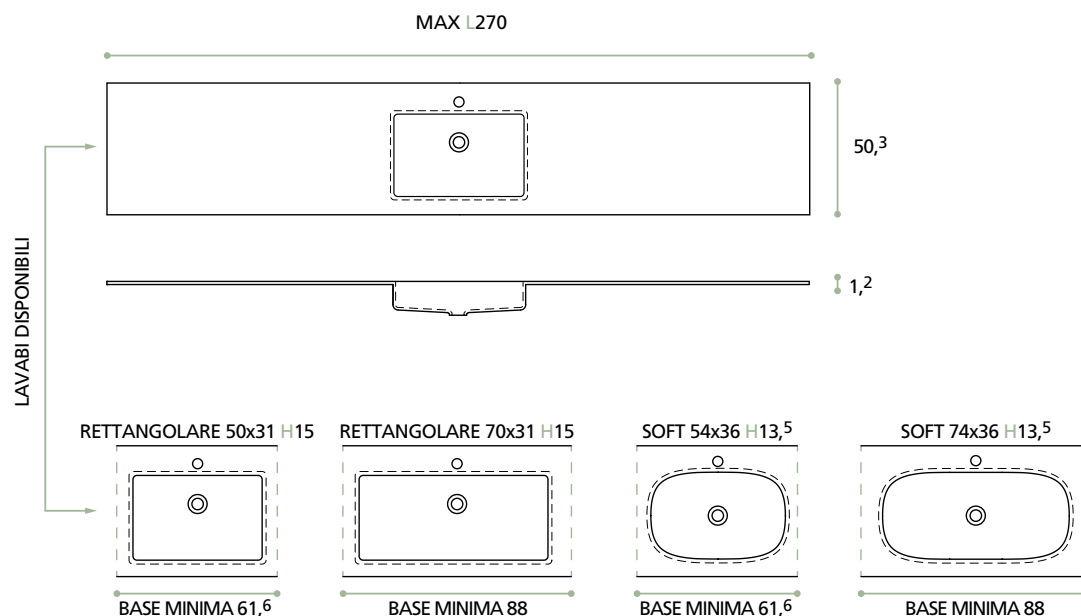

LUNGHEZZA FINO A CM	GEACRYL Sp 1,2		TECNORIL Sp 1,2	
	1LAVABO	2LAVABI	1LAVABO	2LAVABI
60,5 *	681		749	
70,5	724		793	
80,5	745		837	
90,5	766		881	
100,5	787		925	
110,5	809		969	
120,5	830	1660	1013	1629
130,5	851	1703	1057	1673
140,5	872	1745	1101	1717
150,5	894	1788	1145	1761
160,5	915	1830	1189	1805
170,5	936	1873	1233	1849
180,5	958	1916	1277	1894
190,5	979	1958	1321	1938
200,5	1000	2001	1365	1982
210,5	1022	2043	1409	2026
220,5	1043	2086	1453	2070

LAVORAZIONI AGGIUNTIVE

Fresata o asola per porta salviette (su una faccia) 120

ALZATINE spessore 12 mm

fino H10 1,30 cml
da H10,1 a H20 2,30 cml

PROF 51,5 per tutti i modelli escluso FLOW - senza kit di scarico troppo pieno necessita di piletta H3,5

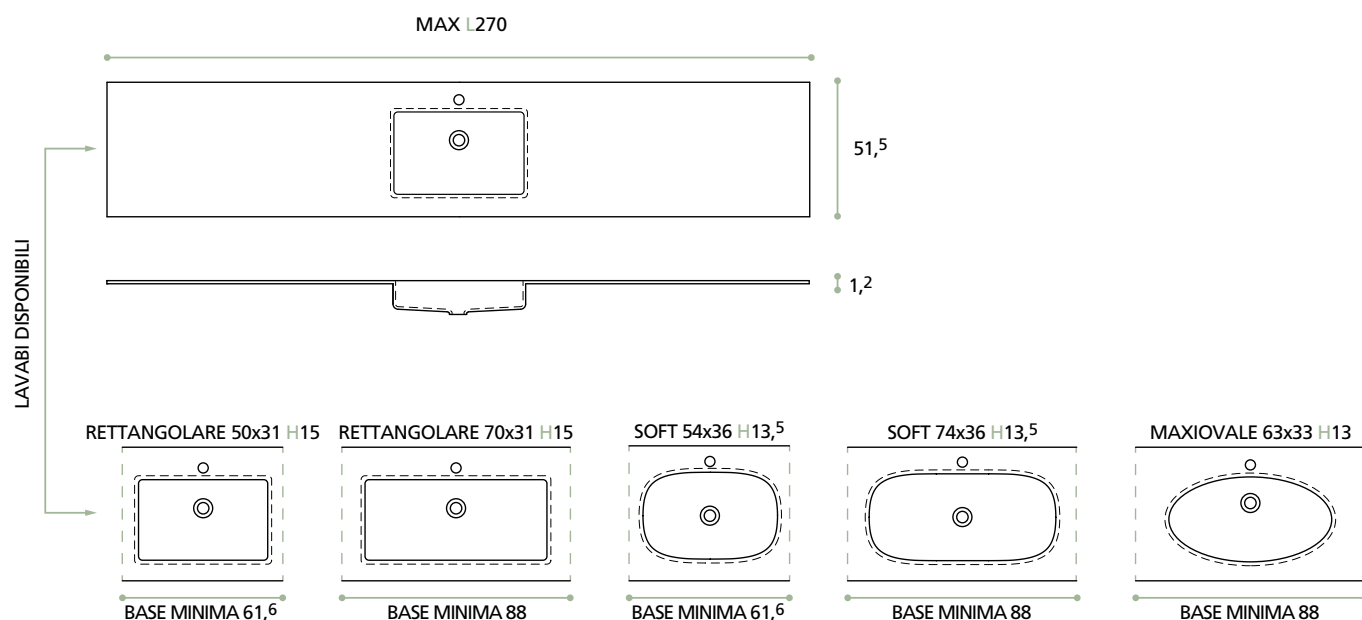

LUNGHEZZA FINO A CM	GEACRYL Sp 1,2		TECNORIL Sp 1,2		
	1LAVABO	2LAVABI	1LAVABO	2LAVABI	
60,5 *	681		749		
70,5	724		793		
80,5	745		837		
90,5	766		881		
100,5	787		925		
110,5	809		969		
120,5	830	1660	1013	1629	
130,5	851	1703	1057	1673	
140,5	872	1745	1101	1717	
150,5	894	1788	1145	1761	
160,5	915	1830	1189	1805	
170,5	936	1873	1233	1849	
180,5	958	1916	1277	1894	
190,5	979	1958	1321	1938	
200,5	1000	2001	1365	1982	
210,5	1022	2043	1409	2026	
220,5	1043	2086	1453	2070	

LAVORAZIONI AGGIUNTIVE

Fresata o asola per porta salviette (su una faccia) 120

ALZATINE spessore 12 mm

fino H10 1,30 cml
da H10,1 a H20 2,30 cml