

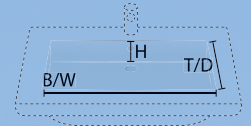

Mineralmarmor Waschtisch weiß alpin Glanz marble minerals washbasin gloss alpine white

 ≈ Beckenmaße in cm (BxHxT)
basin dimensions in cm (WxHxD)



MWAZU(L)6 |  56 x 12 x 30 cm



MWAZU(L)8 |  68 x 12 x 30 cm



MWAZU(L)10 |  68 x 12 x 30 cm



MWAZU(L)12D |  56 x 12 x 30 cm



MWAZU(L)14D |  61 x 12 x 30 cm



Detailfoto

(L) mit LED-Beleuchtung
(L) with LED lighting

Mineralmarmor Glanz/gloss marble minerals

PG1



weiß alpin Glanz
gloss alpine white
AZ69

PG2



granit weiß
white granite
AZ74

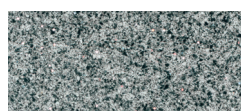

granit grau
grey granite
AZ73

Schränke/cabinets AZURE

Frontfarben/front colours

MDF-foliiert/MDF-coated

<p>449</p>  <p>Kastanie graphit Nachbildung graphite chestnut finish AZC_</p>	<p>451</p>  <p>Teak natur Nachbildung natural teak AZT_</p>
<p>467</p>  <p>Eiche natur Nachbildung nature oak AZV_</p>	<p>961</p>  <p>weiß Glanz gloss white AZG_</p>
<p>458</p>  <p>Robinie dunkel Nachbildung robinia dark AZJ_</p>	<p>438</p>  <p>anthrazit Glanz gloss anthracite AZF_</p>

Korpusfarben/basic shell colours

PG 2

<p>286</p>  <p>weiß Seidenglanz silk gloss white E/AZ86</p>	<p>458</p>  <p>Robinie dunkel Nachbildung robinia dark J/AZ58</p>
<p>467</p>  <p>Eiche natur Nachbildung nature oak V/AZ61</p>	<p>449</p>  <p>Kastanie graphit Nachbildung graphite chestnut finish C/AZ45</p>
<p>481</p>  <p>Teak natur Nachbildung natural teak T/AZ51</p>	

PG 3

<p>042</p>  <p>weiß Glanz gloss white G/AZ50</p>	<p>438</p>  <p>anthrazit Glanz gloss anthracite F/AZ30</p>
------------------------------------------------------------------------------------------------------------------------------------------------------------	----------------------------------------------------------------------------------------------------------------------------------------------------------------------

Griffe/handles

⊕—⊕ = Bohrabstand/hole spacing



chrom Glanz
gloss chrome
285/286
⊕—⊕ 160 mm/320 mm

Schubkästen und Auszüge *drawers and extensions*



Die neuen Schubkästen und Auszüge mit hervorragenden Laufeigenschaften und einem stabilen Vollauszug als Doppelwandstahlzarge mit Selbsteinzug sowie integrierter Dämpfung sind in den Programmen AZURE, IDEA, JOICE und LOOP enthalten.



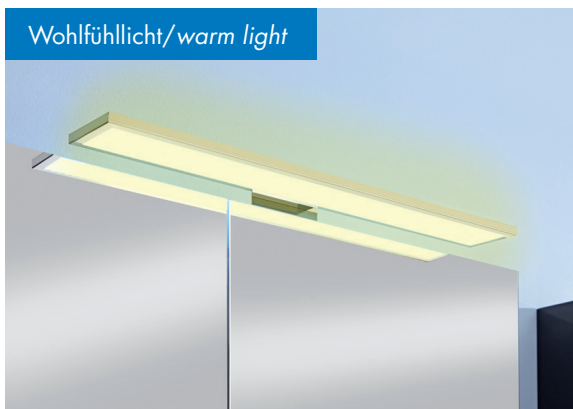

The new drawers and pull-outs with excellent running characteristics and a solid double wall steel frame for full pull-out and self-closing, as well as integrated damping are all part of the new programs AZURE, IDEA, JOICE and LOOP.

Lichtfarben *luminous colours*

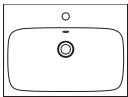
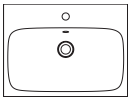

Viele Artikel sind zwischen 2 Lichtfarben (Tageslicht und Wohlfühllicht) umschaltbar.
Sehen Sie hierzu die Beschreibungen der einzelnen Artikel in den Programmen AZURE, IDEA, JOICE und LOOP.

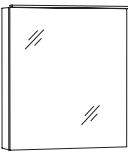
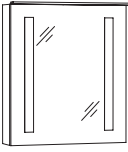
*A lot of articles have 2 light colours (natural light and warm light) which are switchable.
See declaration of articles for the programs AZURE, IDEA, JOICE and LOOP.*

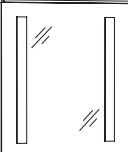
Beschreibung Description	Maße in cm Dimensions in cm			Artikel-Nr. Article no.	Türanschlag	Identnummer ID number	
	B/W	H	T/D			PG1 weiß alpin/gloss white	PG2 granit/granite
 <p>Mineralmarmor-Waschtisch inkl. Überlauf <i>marble minerals washbasin incl. overflow</i></p>	60,5	1,5	45	MWAZU6		493.--	617.--
 <p>Mineralmarmor-Waschtisch mit LED-Beleuchtung EEK A–A++ inkl. Überlauf. Nur in 6000 Kelvin (Tageslicht) erhältlich <i>marble minerals washbasin with LED lighting EEC A–A++ incl. overflow. Only available in 6000 kelvin (natural light)</i></p>	60,5	3	45	MWAZUL6 LED		700.--	823.--
 <p>Waschtisch-Unterschrank 2 Auszüge <i>washbasin base cabinet 2 extensions</i></p>	60	47,8	44,5	DWMZAA6		712.--	825.--
 <p>Spiegelschrank, 1 vollflächig verspiegelte Tür, 2 Glaseinlegeböden, LED Beleuchtung FLS60 10,8 W inkl. Schalter/Steckdose umschaltbar in 2 Lichtfarben EEK A–A++ <i>mirror cabinet, 1 full mirrored door 2 glass shelves, LED lighting FLS60 10,8 W incl. switch/socket two switchable luminous colours EEC A–A++</i></p>	60	68,2	13,6	SFLA6	L/R		1032.--
 <p>Spiegelschrank, 1 vollflächig verspiegelte Tür mit beleuchteten satinierten Flächen 25,6 W, 2 Glaseinlegeböden, LED Beleuchtung FLS60 10,8 W inkl. Schalter/Steckdose umschaltbar in 2 Lichtfarben EEK A–A++ <i>mirror cabinet, 1 full mirrored door with illuminated satinated stripe 25,6 W, 2 glass shelves, LED lighting FLS60 10,8 W incl. switch/socket two switchable luminous colours EEC A–A++</i></p>	60	68,2	13,6	SFLS6	L/R		1282.--
 <p>Spiegelpaneel, LED Beleuchtung FLS60 10,8 W inkl. Schalter umschaltbar in 2 Lichtfarben EEK A–A++ <i>mirror panel, LED lighting FLS60 10,8 W incl. switch two switchable luminous colours EEC A–A++</i></p>	60	68,2	2,8	SPFLA6			812.--
 <p>Spiegelpaneel mit beleuchteten satinierten Flächen 25,6 W, LED Beleuchtung FLS60 10,8 W inkl. Schalter umschaltbar in 2 Lichtfarben EEK A–A++ <i>mirror panel with illuminated satinated stripe 25,6 W, LED lighting FLS60 10,8 W incl. switch two switchable luminous colours EEC A–A++</i></p>	60	68,2	2,8	SPFLS6			1100.--

EEK/EEC=Energieeffizienzklasse/energy efficiency category

Beschreibung Description	Maße in cm Dimensions in cm			Artikel-Nr. Article no.	Türanschlag	Identnummer ID number
	B/W	H	T/D			

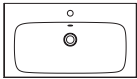
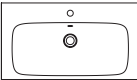
						PG1 weiß alpin/gloss white	PG2 granit/granite
	Mineralmarmor-Waschtisch inkl. Überlauf <i>marble minerals washbasin incl. overflow</i>	80,5	1,5	45	MWAZU8	550.--	687.--
	Mineralmarmor-Waschtisch mit LED-Beleuchtung EEK A-A++ inkl. Überlauf. Nur in 6000 Kelvin (Tageslicht) erhältlich <i>marble minerals washbasin with LED lighting EEC A-A++ incl. overflow. Only available in 6000 kelvin (natural light)</i>	80,5	3	45	MWAZU8 LED	775.--	912.--

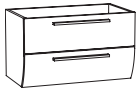
						PG2 matt/matt	PG3 Glanz/gloss
	Waschtisch-Unterschrank 2 Auszüge <i>washbasin base cabinet 2 extensions</i>	80	47,8	44,5	DWMZAA8	844.--	954.--

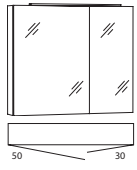
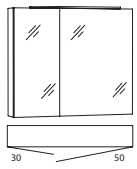

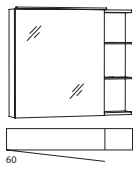
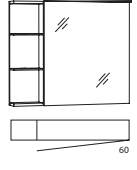
	Spiegelschrank, 2 vollflächig verspiegelte Türen, 2 Glaseinlegeböden, LED Beleuchtung FLS60 10,8 W inkl. Schalter/Steckdose umschaltbar in 2 Lichtfarben EEK A-A++ <i>mirror cabinet, 2 full mirrored doors 2 glass shelves, LED lighting FLS60 10,8 W incl. switch/socket two switchable luminous colours EEC A-A++</i>	80	68,2	13,6	SFLA8L		1180.--
					SFLA8R		

	Spiegelschrank, 1 vollflächig verspiegelte Tür, 1 Regal, 2 Glaseinlegeböden, LED Beleuchtung FLS60 10,8 W inkl. Schalter/Steckdose umschaltbar in 2 Lichtfarben EEK A-A++ <i>mirror cabinet, 1 full mirrored door, 1 shelf 2 glass shelves, LED lighting FLS60 10,8 W incl. switch/socket two switchable luminous colours EEC A-A++</i>	80	68,2	13,6	SFLAR8L	L	1196.--
					SFLAR8R	R	

	Spiegelpaneel LED Beleuchtung FLS60 10,8 W inkl. Schalter umschaltbar in 2 Lichtfarben EEK A-A++ <i>mirror panel, LED lighting FLS60 10,8 W incl. switch, two switchable luminous colours EEC A-A++</i>	80	68,2	2,8	SPFLA8		836.--
-------------------------------------------------------------------------------------	------------------------------------------------------------------------------------------------------------------------------------------------------------------------------------------------------------------------------------------------	----	------	-----	--------	--	---------------

EEK/EEC=Energieeffizienzklasse/energy efficiency category

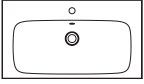
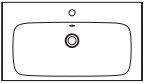
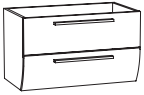
AZURE »80 Spiegelfläche satiniert/satinated mirror-stripes«

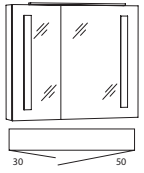
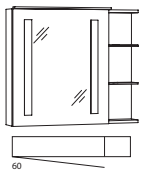
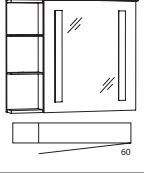
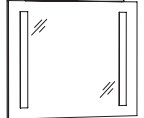
Beschreibung Description	Maße in cm Dimensions in cm			Artikel-Nr. Article no.	Türanschlag	Identnummer ID number	
	B/W	H	T/D			PG1 weiß alpin/gloss white	PG2 granit/granite
 <p>Mineralmarmor-Waschtisch inkl. Überlauf <i>marble minerals washbasin incl. overflow</i></p>	80,5	1,5	45	MWAZU8		550.--	687.--
 <p>Mineralmarmor-Waschtisch mit LED-Beleuchtung EEK A–A++ inkl. Überlauf. Nur in 6000 Kelvin (Tageslicht) erhältlich <i>marble minerals washbasin with LED lighting EEC A–A++ incl. overflow. Only available in 6000 kelvin (natural light)</i></p>	80,5	3	45	MWAZUL8 LED		775.--	912.--
 <p>Waschtisch-Unterschrank 2 Auszüge <i>washbasin base cabinet 2 extensions</i></p>	80	47,8	44,5	DWMZAA8		844.--	954.--
 <p>Spiegelschrank, 2 vollflächig verspiegelte Türen mit beleuchteten satinierten Flächen 25,6 W, 2 Glaseinlegeböden, LED Beleuchtung FLS60 10,8 W inkl. Schalter/Steckdose umschaltbar in 2 Lichtfarben EEK A–A++ <i>mirror cabinet, 2 full mirrored doors with illuminated satinated stripe 25,6 W, 2 glass shelves, LED lighting FLS60 10,8 W incl. switch/socket two switchable luminous colours EEC A–A++</i></p>	80	68,2	13,6	SFLS8L		1534.--	
 <p></p>				SFLS8R			
 <p>Spiegelschrank, 1 vollflächig verspiegelte Tür mit beleuchteten satinierten Flächen 25,6 W, 1 Regal, 2 Glaseinlegeböden, LED Beleuchtung FLS60 10,8 W inkl. Schalter/Steckdose umschaltbar in 2 Lichtfarben EEK A–A++ <i>mirror cabinet, 1 full mirrored door with illuminated satinated stripe 25,6 W, 1 shelf, 2 glass shelves, LED lighting FLS60 10,8 W incl. switch/socket two switchable luminous colours EEC A–A++</i></p>	80	68,2	13,6	SFLSR8L	L	1444.--	
 <p></p>				SFLSR8R	R		
 <p>Spiegelpaneel mit beleuchteten satinierten Flächen 25,6 W, LED Beleuchtung FLS60 10,8 W inkl. Schalter umschaltbar in 2 Lichtfarben EEK A–A++ <i>mirror panel with illuminated satinated stripe 25,6 W, LED lighting FLS60 10,8 W incl. switch, two switchable luminous colours EEC A–A++</i></p>	80	68,2	2,8	SPFLS8		1141.--	

EEK/EEC=Energieeffizienzklasse/energy efficiency category

Beschreibung Description	Maße in cm Dimensions in cm			Artikel-Nr. Article no.	Türanschlag	Identnummer ID number	
	B/W	H	T/D				

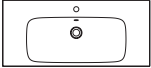
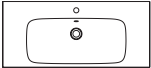
						PG1 weiß alpin/gloss white	PG2 granit/granite
	Mineralmarmor-Waschtisch inkl. Überlauf <i>marble minerals washbasin incl. overflow</i>	100,5	1,5	45	MWAZU10	630.--	787.--
	Mineralmarmor-Waschtisch mit LED-Beleuchtung EEK A-A++ inkl. Überlauf. Nur in 6000 Kelvin (Tageslicht) erhältlich <i>marble minerals washbasin with LED lighting EEC A-A++ incl. overflow. Only available in 6000 kelvin (natural light)</i>	100,5	3	45	MWAZUL10 LED	873.--	1030.--

						PG2 matt/matt	PG3 Glanz/gloss
	Waschtisch-Unterschrank 2 Auszüge <i>washbasin base cabinet 2 extensions</i>	100	47,8	44,5	DWMZAA10	899.--	1011.--

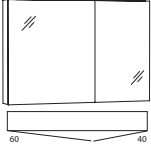
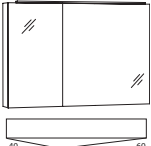

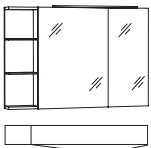
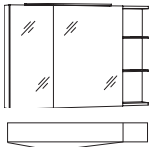

	Spiegelschrank, 2 vollflächig verspiegelte Türen, 2 Glaseinlegeböden, LED Beleuchtung FLS90 17,3 W inkl. Schalter/Steckdose umschaltbar in 2 Lichtfarben EEK A-A++ <i>mirror cabinet, 2 full mirrored doors 2 glass shelves, LED lighting FLS90 17,3 W incl. switch/socket two switchable luminous colours EEC A-A++</i>	100	68,2	13,6	SFLA10L	1298.--
					SFLA10R	

	Spiegelschrank, 2 vollflächig verspiegelte Türen, 1 Regal, 2 Glaseinlegeböden, LED Beleuchtung FLS60 10,8 W inkl. Schalter/Steckdose umschaltbar in 2 Lichtfarben EEK A-A++ <i>mirror cabinet, 2 full mirrored doors, 1 shelf 2 glass shelves, LED lighting FLS60 10,8 W incl. switch/socket two switchable luminous colours EEC A-A++</i>	100	68,2	13,6	SFLAR10L	1331.--
					SFLAR10R	



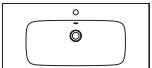

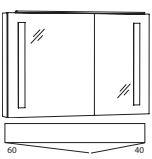
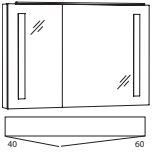
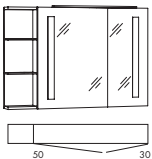
	Spiegelpaneel LED Beleuchtung FLS90 17,3 W inkl. Schalter umschaltbar in 2 Lichtfarben EEK A-A++ <i>mirror panel, LED lighting FLS90 17,3 W incl. switch two switchable luminous colours EEC A-A++</i>	100	68,2	2,8	SPFLA10	866.--
-------------------------------------------------------------------------------------	-----------------------------------------------------------------------------------------------------------------------------------------------------------------------------------------------------------------------------------------------	-----	------	-----	---------	---------------

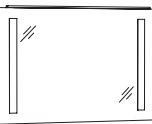
EEK/EEC=Energieeffizienzklasse/energy efficiency category

AZURE »100 Spiegelfläche satiniert/ *satinated mirror-stripes*«

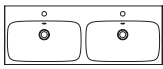

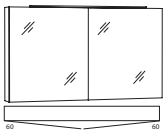
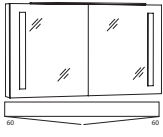
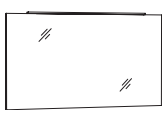

Beschreibung <i>Description</i>	Maße in cm <i>Dimensions in cm</i>			Artikel-Nr. <i>Article no.</i>	Türanschlag	Identnummer <i>ID number</i>	
	B/W	H	T/D			PG1 <i>weiß alpin/gloss white</i>	PG2 <i>granit/granite</i>
 <p>Mineralmarmor-Waschtisch inkl. Überlauf <i>marble minerals washbasin incl. overflow</i></p>	100,5	1,5	45	MWAZU10		PG1 <i>weiß alpin/gloss white</i> 630.--	PG2 <i>granit/granite</i> 787.--
 <p>Mineralmarmor-Waschtisch mit LED-Beleuchtung EEK A–A++ inkl. Überlauf. Nur in 6000 Kelvin (Tageslicht) erhältlich <i>marble minerals washbasin with LED lighting EEC A–A++ incl. overflow. Only available in 6000 kelvin (natural light)</i></p>	100,5	3	45	MWAZUL10 LED		873.--	1030.--
 <p>Waschtisch-Unterschrank 2 Auszüge <i>washbasin base cabinet 2 extensions</i></p>	100	47,8	44,5	DWMZAA10		PG2 <i>matt/matt</i> 899.--	PG3 <i>Glanz/gloss</i> 1011.--
 <p>Spiegelschrank, 2 vollflächig verspiegelte Türen mit beleuchteten satinierten Flächen 25,6 W, 2 Glaseinlegeböden, LED Beleuchtung FLS90 17,3 W inkl. Schalter/Steckdose umschaltbar in 2 Lichtfarben EEK A–A++ <i>mirror cabinet, 2 full mirrored doors with illuminated satinated stripe 25,6 W, 2 glass shelves, LED lighting FLS90 17,3 W incl. switch/socket two switchable luminous colours EEC A–A++</i></p>	100	68,2	13,6	SFLS10L		1669.--	
 <p>SFLS10R</p>							
 <p>Spiegelschrank, 2 vollflächig verspiegelte Türen mit beleuchteten satinierten Flächen 25,6 W, 1 Regal, 2 Glaseinlegeböden, LED Beleuchtung FLS60 10,8 W inkl. Schalter/Steckdose umschaltbar in 2 Lichtfarben EEK A–A++ <i>mirror cabinet, 2 full mirrored doors, with illuminated satinated stripe 25,6 W, 1 shelf, 2 glass shelves, LED lighting FLS60 10,8 W incl. switch/socket two switchable luminous colours EEC A–A++</i></p>	100	68,2	13,6	SFLSR10L		1683.--	
 <p>SFLSR10R</p>							
 <p>Spiegelpaneel mit beleuchteten satinierten Flächen 25,6 W, LED Beleuchtung FLS90 17,3 W inkl. Schalter umschaltbar in 2 Lichtfarben EEK A–A++ <i>mirror panel with illuminated satinated stripe 25,6 W, LED lighting FLS90 17,3 W incl. switch two switchable luminous colours EEC A–A++</i></p>	100	68,2	2,8	SPFLS10		1182.--	

EEK/EEC=Energieeffizienzklasse/energy efficiency category



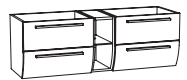
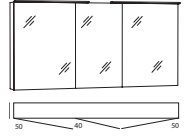
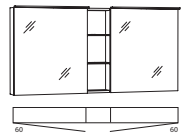

Beschreibung Description	Maße in cm Dimensions in cm			Artikel-Nr. Article no.	Türanschlag	Identnummer ID number	
	B/W	H	T/D			PG1 weiß alpin/gloss white	PG2 granit/granite
 Mineralmarmor-Doppel-Waschtisch inkl. Überlauf <i>marble minerals double washbasin incl. overflow</i>	120,5	1,5	45	MWAZU12D		786.--	983.--
 Mineralmarmor-Doppel-Waschtisch mit LED-Beleuchtung EEK A–A++ inkl. Überlauf. Nur in 6000 Kelvin (Tageslicht) erhältlich <i>marble minerals double washbasin with LED lighting EEC A–A++ incl. overflow. Only available in 6000 kelvin (natural light)</i>	120,5	3	45	MWAZUL12D LED		1045.--	1241.--
 Waschtisch-Unterschrank 4 Auszüge <i>washbasin base cabinet 4 extensions</i>	120	47,8	44,5	DWMZAAAA12		1493.--	1604.--
 Spiegelschrank, 2 vollflächig verspiegelte Türen, 4 Glaseinlegeböden, LED Beleuchtung FLS90 17,3 W inkl. Schalter/Steckdose umschaltbar in 2 Lichtfarben EEK A–A++ <i>mirror cabinet, 2 full mirrored doors 4 glass shelves, LED lighting FLS90 17,3 W incl. switch/socket two switchable luminous colours EEC A–A++</i>	120	68,2	13,6	SFLA12		1570.--	
 Spiegelschrank, 2 vollflächig verspiegelte Türen mit beleuchteten satinierten Flächen 25,6W, 4 Glaseinlegeböden, LED Beleuchtung FLS90 17,3 W inkl. Schalter/Steckdose umschaltbar in 2 Lichtfarben EEK A–A++ <i>mirror cabinet, 2 full mirrored doors with illuminated satinated stripe 25,6 W, 4 glass shelves, LED lighting FLS90 17,3 W incl. switch/socket two switchable luminous colours EEC A–A++</i>	120	68,2	13,6	SFLS12		2038.--	
 Spiegelpaneel LED Beleuchtung FLS90 17,3 W inkl. Schalter umschaltbar in 2 Lichtfarben EEK A–A++ <i>mirror panel, LED lighting FLS90 17,3 W incl. switch, two switchable luminous colours EEC A–A++</i>	120	68,2	2,8	SPFLA12		894.--	
 Spiegelpaneel mit beleuchteten satinierten Flächen 25,6 W, LED Beleuchtung FLS90 17,3 W inkl. Schalter umschaltbar in 2 Lichtfarben EEK A–A++ <i>mirror panel with illuminated satinated stripe 25,6 W, LED lighting FLS90 17,3 W incl. switch two switchable luminous colours EEC A–A++</i>	120	68,2	2,8	SPFLS12		1224.--	

EEK/EEC=Energieeffizienzklasse/energy efficiency category



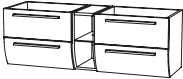
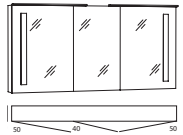
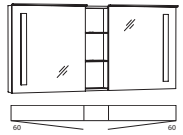

AZURE »140 Spiegelfläche/mirror-stripes«





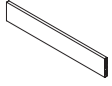
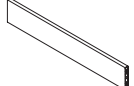

Beschreibung Description	Maße in cm Dimensions in cm			Artikel-Nr. Article no.	Türanschlag	Identnummer ID number	
	B/W	H	T/D			PG1 weiß alpin/gloss white	PG2 granit/granite
 <p>Mineralmarmor-Doppel-Waschtisch inkl. Überlauf <i>marble minerals double washbasin incl. overflow</i></p>	140,5	1,5	45	MWAZU14D		916.--	1145.--
 <p>Mineralmarmor-Doppel-Waschtisch mit LED-Beleuchtung EEK A-A++ inkl. Überlauf. Nur in 6000 Kelvin (Tageslicht) erhältlich <i>marble minerals double washbasin with LED lighting EEC A-A++ incl. overflow. Only available in 6000 kelvin (natural light)</i></p>	140,5	3	45	MWAZUL14D LED		1191.--	1420.--
 <p>Waschtisch-Unterschrank 4 Auszüge, 1 Regal mittig <i>washbasin base cabinet 4 extensions, 1 shelf in center</i></p>	140	47,8	44,5	DWMZAAAA14		1642.--	1754.--
 <p>Spiegelschrank, 3 vollflächig verspiegelte Türen, 4 Glaseinlegeböden, LED Beleuchtung 2xFLS60 21,6 W inkl. Schalter/Steckdose umschaltbar in 2 Lichtfarben EEK A-A++ <i>mirror cabinet, 3 full mirrored doors 4 glass shelves, LED lighting 2xFLS60 21,6 W incl. switch/socket two switchable luminous colours EEC A-A++</i></p>	140	68,2	13,6	SFLA14		1876.--	
 <p>Spiegelschrank, 2 vollflächig verspiegelte Türen, 1 Regal mittig, 4 Glaseinlegeböden, LED Beleuchtung 2xFLS60 21,6 W inkl. Schalter/Steckdose umschaltbar in 2 Lichtfarben EEK A-A++ <i>mirror cabinet, 2 full mirrored doors, 1 shelf in center, 4 glass shelves, LED lighting 2xFLS60 21,6 W incl. switch/socket two switchable luminous colours EEC A-A++</i></p>	140	68,2	13,6	SFLAR14		2214.--	
 <p>Spiegelpaneel LED Beleuchtung FLS90 17,3 W inkl. Schalter umschaltbar in 2 Lichtfarben EEK A-A++ <i>mirror panel, LED lighting FLS90 17,3 W incl. switch, two switchable luminous colours EEC A-A++</i></p>	140	68,2	2,8	SPFLA14		921.--	

EEK/EEC=Energieeffizienzklasse/energy efficiency category

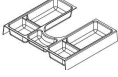
Beschreibung <i>Description</i>	Maße in cm <i>Dimensions in cm</i>			Artikel-Nr. <i>Article no.</i>	Türanschlag	Identnummer <i>ID number</i>	
	B/W	H	T/D			PG1 weiß alpin/gloss white	PG2 granit/granite
 <p>Mineralmarmor-Doppel-Waschtisch inkl. Überlauf <i>marble minerals double washbasin incl. overflow</i></p>	140,5	1,5	45	MWAZU14D		916.--	1145.--
 <p>Mineralmarmor-Doppel-Waschtisch mit LED-Beleuchtung EEK A-A++ inkl. Überlauf. Nur in 6000 Kelvin (Tageslicht) erhältlich <i>marble minerals double washbasin with LED lighting EEC A-A++ incl. overflow. Only available in 6000 kelvin (natural light)</i></p>	140,5	3	45	MWAZUL14D LED		1191.--	1420.--
 <p>Waschtisch-Unterschrank 4 Auszüge, 1 Regal mittig <i>washbasin base cabinet 4 extensions, 1 shelf in center</i></p>	140	47,8	44,5	DWMZAAAA14		1642.--	1754.--
 <p>Spiegelschrank, 3 vollflächig verspiegelte Türen mit beleuchteten satinierten Flächen 25,6 W, 4 Glaseinlegeböden, LED Beleuchtung 2xFLS60 21,6 W inkl. Schalter/Steckdose umschaltbar in 2 Lichtfarben EEK A-A++ <i>mirror cabinet, 3 full mirrored doors with illuminated satinated stripe 25,6 W, 4 glass shelves, LED lighting 2xFLS60 21,6 W incl. switch/socket two switchable luminous colours EEC A-A++</i></p>	140	68,2	13,6	SFLS14			2343.--
 <p>Spiegelschrank, 2 vollflächig verspiegelte Türen mit beleuchteten satinierten Flächen 25,6 W, 1 Regal mittig, 4 Glaseinl., LED Beleuchtung 2xFLS60 21,6 W inkl. Schalter/Steckdose umschaltbar in 2 Lichtfarben EEK A-A++ <i>mirror cabinet, 2 full mirrored doors, with illuminated satinated stripe 25,6 W, 1 shelf in center, 4 glass shelves, LED lighting 2xFLS60 21,6 W incl. switch/socket two switchable luminous colours EEC A-A++</i></p>	140	68,2	13,6	SFLSR14			2575.--
 <p>Spiegelpaneel mit beleuchteten satinierten Flächen 25,6 W, LED Beleuchtung FLS90 17,3 W inkl. Schalter umschaltbar in 2 Lichtfarben EEK A-A++ <i>mirror panel with illuminated satinated stripe 25,6 W, LED lighting FLS90 17,3 W incl. switch two switchable luminous colours EEC A-A++</i></p>	140	68,2	2,8	SPFLS14			1265.--





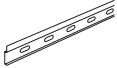

EEK/EEC=Energieeffizienzklasse/energy efficiency category

Beschreibung <i>Description</i>	Maße in cm <i>Dimensions in cm</i>			Artikel-Nr. <i>Article no.</i>	Türanschlag	Identnummer <i>ID number</i>
	B/W	H	T/D			
 <p>Handtuchhalter verchromt (Befestigung am Schrank) <i>chromed towel rail (fastening on the cabinet)</i></p>	5	2,5	40	MHH		126.--
 <p>Handtuchhalter 2-armig (Befestigung am Schrank) ausziehbar <i>towel rail 2-arms (fastening on the cabinet) pull out</i></p>	10,5	4	32,5/ 50	HH233		76.--
 <p>Handtuchhalter 1-armig (Befestigung am Schrank) ausziehbar <i>towel rail 1-arm (fastening on the cabinet) pull out</i></p>	10,5	4	32,5/ 50	HH133		60.--
 <p>Handtuchhalter 1-armig (Befestigung am Schrank) <i>towel rail 1-arm (fastening on the cabinet)</i></p>	5	1	33	HHF133		33.--
 <p>Inneneinteilung für 60 cm Auszug <i>internal subdivision for 60 cm extension</i></p>				IEG60		97.--
 <p>Inneneinteilung für 80 cm Auszug <i>internal subdivision for 80 cm extension</i></p>				IEG80		97.--
 <p>Inneneinteilung für 100 cm Auszug <i>internal subdivision for 100 cm extension</i></p>				IEG100		97.--

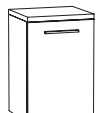

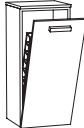
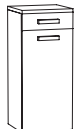
Beschreibung Description	Maße in cm Dimensions in cm			Artikel-Nr. Article no.	Türanschlag	Identnummer ID number
	B/W	H	T/D			
 Schubkasteneinsatz (Kunststoff) für oberen Auszug vom WT-Unterschrank <i>drawer insert part (plastic) for top drawer from base cabinet</i>	33,7	4,3	28	SABEG3		32.--
 Schubkasteneinsatz (Kunststoff) für Schubkasten 40 cm <i>drawer insert part (plastic) for drawer 40 cm</i>				SEG4		35.--
 Innenauszug für Beistellschränke 40 cm <i>internal drawer for side cabinets 40 cm</i>				ISG40		140.--
 Spiegelschrank-Unterbauleuchtung 3W LED EEK A-A++ (für Spiegelschrank ab 80 cm Breite) Nur in 6000 Kelvin (Tageslicht) erhältlich <i>base lighting for mirror cabinet 3W LED EEC A-A++ (for mirror cabinet ex 80 cm width) only available in 6000 kelvin (natural light)</i>	70			WTB70		142.--
 Spiegelschrank-Unterbauleuchtung 4,3W LED EEK A-A++ (für Spiegelschrank ab 120 cm Breite) Nur in 6000 Kelvin (Tageslicht) erhältlich <i>base lighting for mirror cabinet 4,3W LED EEC A-A++ (for mirror cabinet ex 120 cm width) only available in 6000 kelvin (natural light)</i>	110			WTB110		205.--
 LED-Unterbauleuchte (2er Set) 6,0 W EEK A-A++ Nur in 4000 Kelvin (Wohlfühllicht) erhältlich <i>LED base lighting (2 pcs / unit) 6,0 W EEC A-A++ only available in 4000 kelvin (warm light)</i>	10		10	WTBF210		270.--
 Montageschiene inkl. Befestigungsmaterial <i>mounting rail incl. fastening material</i>	210			MS210-4		89.--

EEK/EEC=Energieeffizienzklasse/energy efficiency category

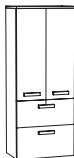
AZURE Beistellschränke/ *side cabinets*

Beschreibung <i>Description</i>	Maße in cm <i>Dimensions in cm</i>			Artikel-Nr. <i>Article no.</i>	Türanschlag	Identnummer <i>ID number</i>	
	B/W	H	T/D			PG2 <i>matt/matt</i>	PG3 <i>Glanz/gloss</i>
 <p>Oberschrank 1 Tür 2 Glaseinlegeböden</p> <p><i>top cabinet 1 door 2 glass shelves</i></p>	40	57,4	17,6	DOT4	L/R	300.--	395.--
 <p>Unterschrank inkl. Abdeckplatte 1 Tür, 2 Glaseinlegeböden</p> <p><i>top cabinet 1 door, 2 glass shelves</i></p>	40	59,2	34,8	DUT4F	L/R	330.--	467.--
 <p>Highboard inkl. Abdeckplatte 1 Tür 2 Glaseinlegeböden</p> <p><i>high cabinet incl. top 1 door 2 glass shelves</i></p>	30	91,2	34,8	DHBT3F	L/R	363.--	521.--
	40	91,2	17,6	DHBT4F	L/R		
	40	91,2	34,8	DHBT4F	L/R		
 <p>Highboard inkl. Abdeckplatte 1 Tür/Wäschekippe</p> <p><i>high cabinet incl. top 1 door/linen bin</i></p>	40	91,2	34,8	DHBW4F		427.--	584.--
 <p>Highboard inkl. Abdeckplatte 1 Tür, 1 Schubkasten 2 Glaseinlegeböden</p> <p><i>high cabinet incl. top 1 door, 1 drawer 2 glass shelves</i></p>	40	91,2	34,8	DHBT4F	L/R	521.--	1463.--
 <p>Mittelschrank inkl. Abdeckplatte 2 Türen 3 Glaseinlegeböden</p> <p><i>medium cabinet incl. top 2 doors 3 glass shelves</i></p>	30	148,8	34,8	DMTT3F	L/R	537.--	790.--
	40	148,8	34,8	DMTT4F	L/R		
 <p>Mittelschrank inkl. Abdeckplatte 1 Tür, 2 Auszüge 2 Glaseinlegeböden</p> <p><i>medium cabinet incl. top 1 door, 2 extensions 2 glass shelves</i></p>	40	148,8	34,8	DMTAA4F	L/R	711.--	963.--
 <p>Mittelschrank inkl. Abdeckplatte 4 Türen 3 Glaseinlegeböden</p> <p><i>medium cabinet incl. top 4 doors 3 glass shelves</i></p>	60	148,8	34,8	DMTT6F		902.--	1097.--
 <p>Mittelschrank inkl. Abdeckplatte 2 Türen, 2 Auszüge 2 Glaseinlegeböden</p> <p><i>medium cabinet incl. top 2 doors, 2 extensions 2 glass shelves</i></p>	60	148,8	34,8	DMTAA6F		948.--	1200.--

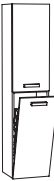
Beschreibung <i>Description</i>	Maße in cm <i>Dimensions in cm</i>			Artikel-Nr. <i>Article no.</i>	Türanschlag	Identnummer <i>ID number</i>	
	B/W	H	T/D			PG2 <i>matt/matt</i>	PG3 <i>Glanz/gloss</i>

						PG2 <i>matt/matt</i>	PG3 <i>Glanz/gloss</i>	
	Hochschrank 2 Türen 4 Glaseinlegeböden	30	178,7	34,8	DHTT3	L/R	537.--	790.--
		40	178,7	17,6	DHFTT4	L/R		
	<i>tower cabinet 2 doors 4 glass shelves</i>	40	178,7	34,8	DHTT4	L/R		
	Hochschrank 1 Tür / 1 Wäschekippe 2 Glaseinlegeböden	40	178,7	34,8	DHTW4	L/R	600.--	853.--
	Hochschrank 2 Türen, 1 Schubkasten 3 Glaseinlegeböden	40	178,7	34,8	DHTST4	L/R	695.--	948.--
	Hochschrank 1 Tür / 3 Auszüge 2 Glaseinlegeböden	40	178,7	34,8	DHTAAA4	L/R	869.--	1121.--

	Schminkschrank inkl. Deckel 1 Tür, 1 Schubkasten 2 Glaseinlegeböden, Kosmetikeinsatz und Vergrößerungsspiegel inkl. LED-Beleuchtung EEK A-A++, Nur in 6000 Kelvin (Tageslicht) erhältlich (nicht mit Korpus weiß Seidenglanz lieferbar)	40	98,3	34,8	DHBKBST4	L/R	1408.--	1463.--
	<i>cosmetik cabinet incl. lid 1 door, 1 drawer 2 glass shelves, cosmetik insert part and magnifying mirror incl. LED lighting EEC A-A++ only available in 6000 kelvin (natural light) (not available with basic shell colour silk gloss white)</i>							

Hochschrank mit Spiegeltür/tower cabinet with mirrored door – AZQ

	Hochschrank 2 Spiegeltüren 4 Glaseinlegeböden	40	178,7	17,6	DHFPP4	L/R	537.--	790.--
		40	178,7	34,8	DHPP4	L/R		
	<i>tower cabinet 2 mirrored doors 4 glass shelves</i>							

EEK/EEC=Energieeffizienzklasse/energy efficiency category

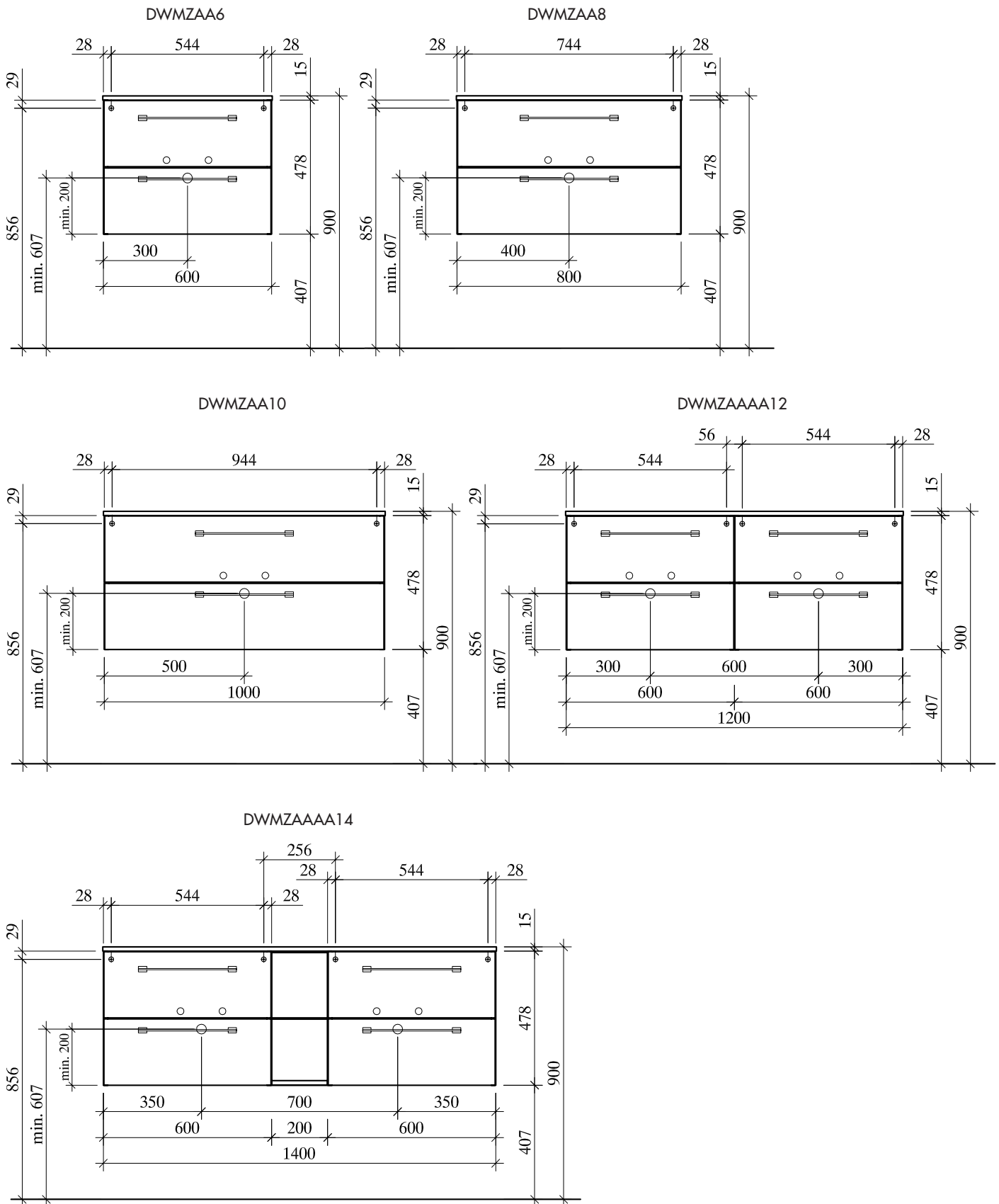

! Achtung: Die Montage muss durch fachkundige Personen erfolgen. Der Untergrund zur Wandbefestigung ist vor Montage zu prüfen. Bitte wählen Sie entsprechend das geeignete Befestigungsmaterial. Fehlerhafte Montagen können das Möbel beschädigen oder dessen Funktion dauerhaft beeinträchtigen. Für Sach- und Personenschäden übernehmen wir im Falle einer unsachgemäßen Montage keine Haftung.
 Attention: Assembly must be carried out by skilled personnel. The subsurface for the wall mounting must be checked before assembly. Please select a suitable mounting material. Faulty assembly can damage furniture or permanently impair its function. We will not be held responsible for damage to material or persons in the case of improper assembly.

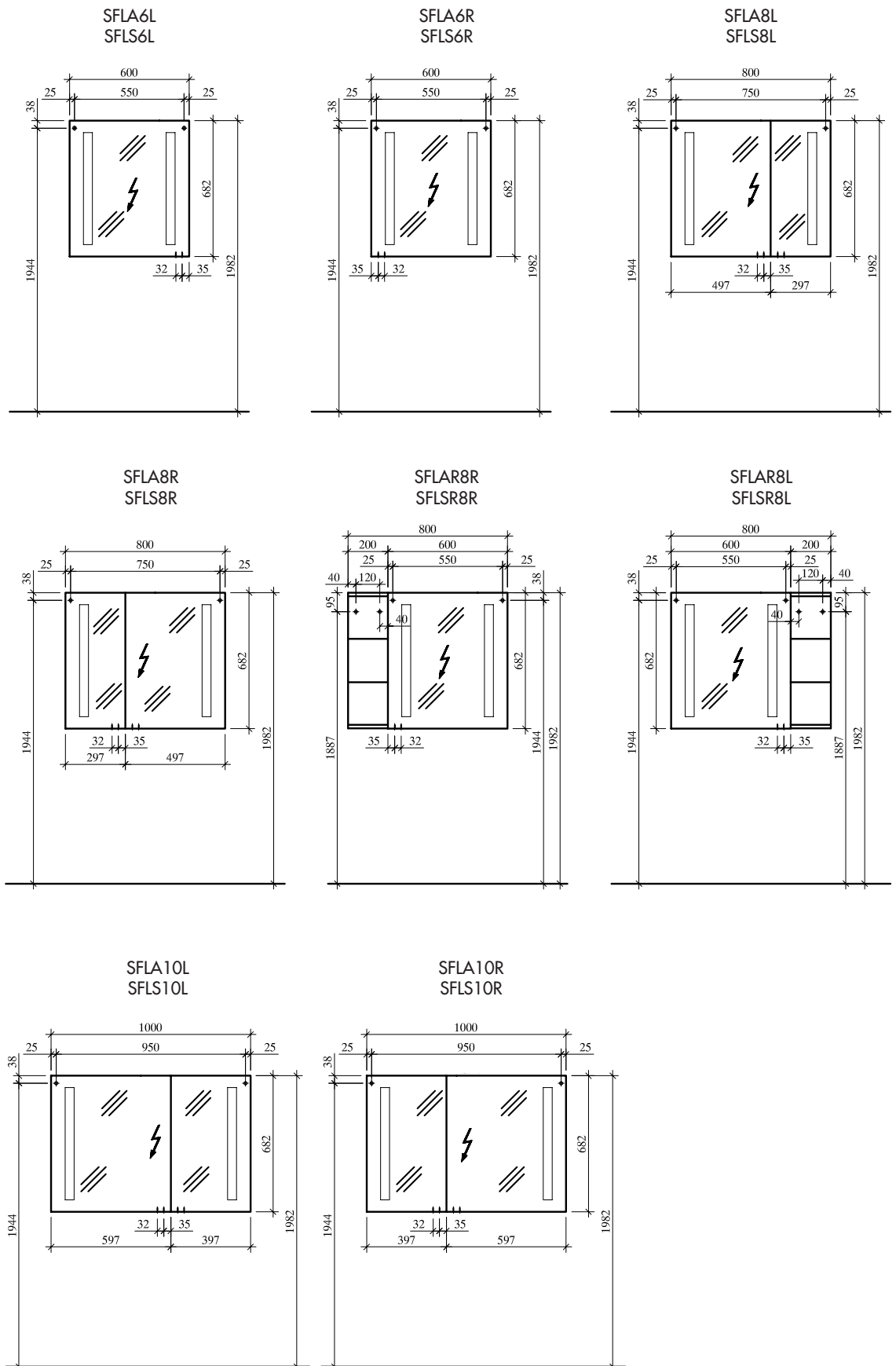

! Achtung: Die Montage muss durch fachkundige Personen erfolgen. Der Untergrund zur Wandbefestigung ist vor Montage zu prüfen. Bitte wählen Sie entsprechend das geeignete Befestigungsmaterial. Fehlerhafte Montagen können das Möbel beschädigen oder dessen Funktion dauerhaft beeinträchtigen. Für Sach- und Personenschäden übernehmen wir im Falle einer unsachgemäßen Montage keine Haftung.
 Attention: Assembly must be carried out by skilled personnel. The subsurface for the wall mounting must be checked before assembly. Please select a suitable mounting material. Faulty assembly can damage furniture or permanently impair its function. We will not be held responsible for damage to material or persons in the case of improper assembly.

SFLAR10L
SFLSR10L

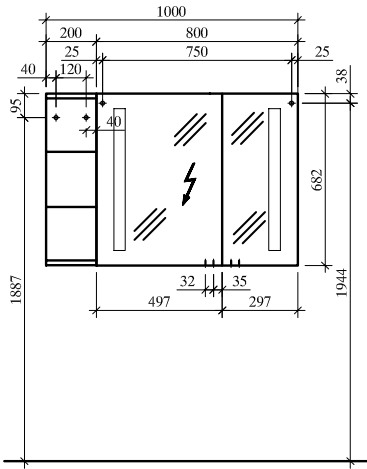

SFLAR10R
SFLSR10R

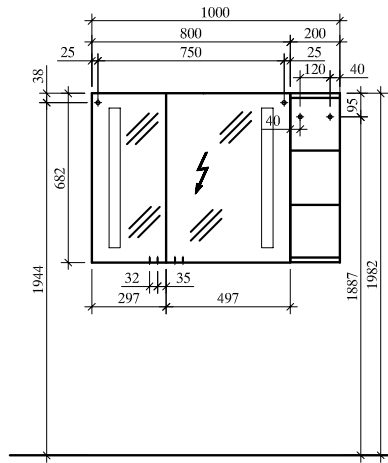

SFLA12
SFLS12

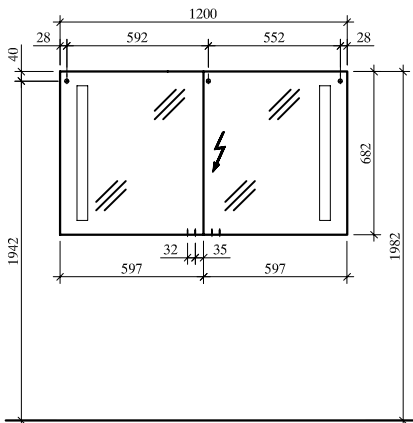

SFLA14
SFLS14

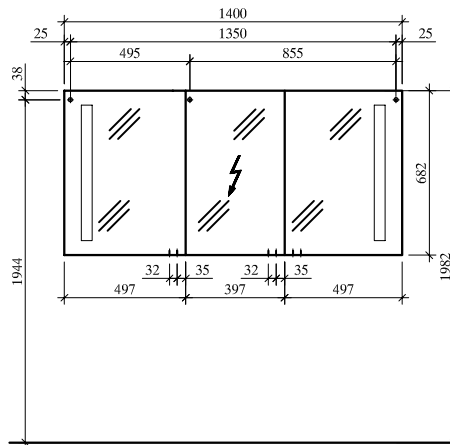

SFLAR14
SFLSR14

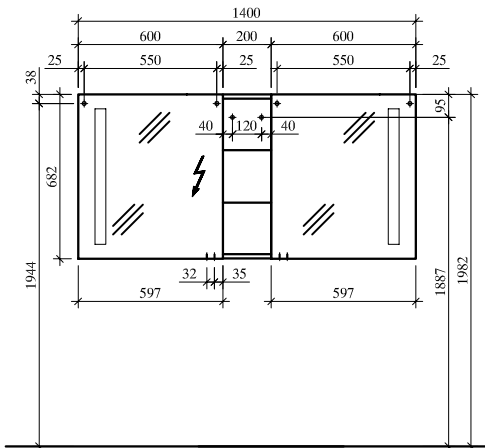

! Achtung: Die Montage muss durch fachkundige Personen erfolgen. Der Untergrund zur Wandbefestigung ist vor Montage zu prüfen. Bitte wählen Sie entsprechend das geeignete Befestigungsmaterial. Fehlerhafte Montagen können das Möbel beschädigen oder dessen Funktion dauerhaft beeinträchtigen. Für Sach- und Personenschäden übernehmen wir im Falle einer unsachgemäßen Montage keine Haftung.

Attention: Assembly must be carried out by skilled personnel. The subsurface for the wall mounting must be checked before assembly. Please select a suitable mounting material. Faulty assembly can damage furniture or permanently impair its function. We will not be held responsible for damage to material or persons in the case of improper assembly.

SPFLA6

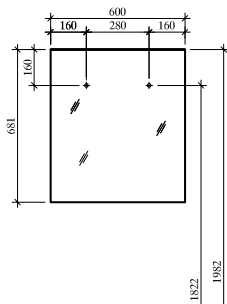

SPFLA8

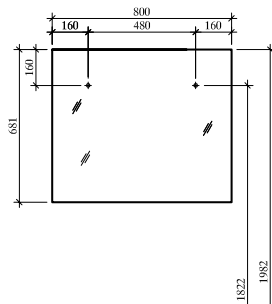

SPFLA10

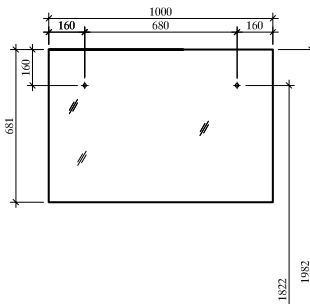

SPFLA12

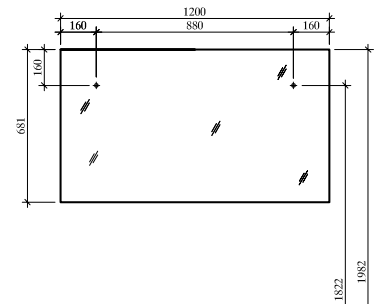

SPFLA14

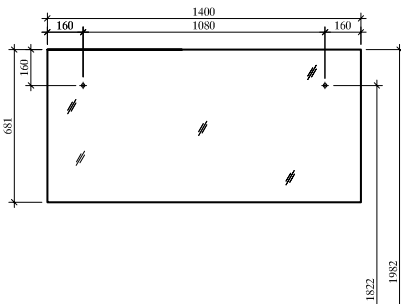

SPFLS6

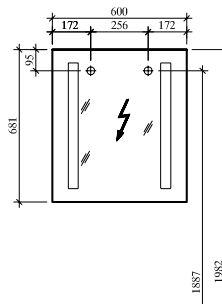

SPFLS8

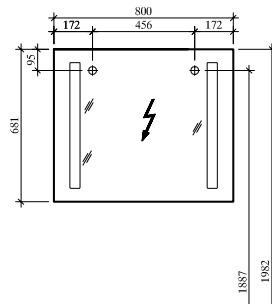

SPFLS10

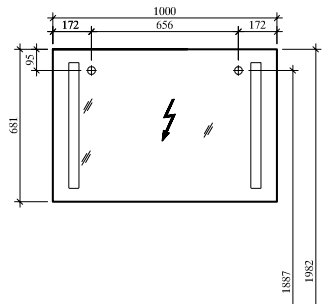

SPFLS12

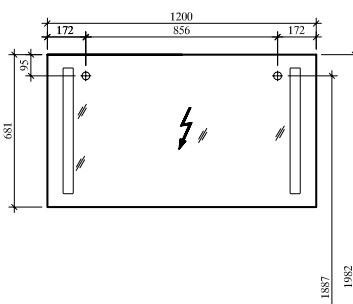

SPFLS14

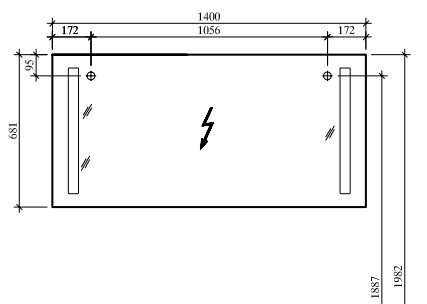

! Achtung: Die Montage muss durch fachkundige Personen erfolgen. Der Untergrund zur Wandbefestigung ist vor Montage zu prüfen. Bitte wählen Sie entsprechend das geeignete Befestigungsmaterial. Fehlerhafte Montagen können das Möbel beschädigen oder dessen Funktion dauerhaft beeinträchtigen. Für Sach- und Personenschäden übernehmen wir im Falle einer unsachgemäßen Montage keine Haftung.
 Attention: Assembly must be carried out by skilled personnel. The subsurface for the wall mounting must be checked before assembly. Please select a suitable mounting material. Faulty assembly can damage furniture or permanently impair its function. We will not be held responsible for damage to material or persons in the case of improper assembly.

DMTT3F DMTT4F

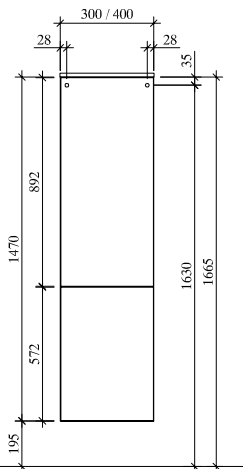

DMTAA4F

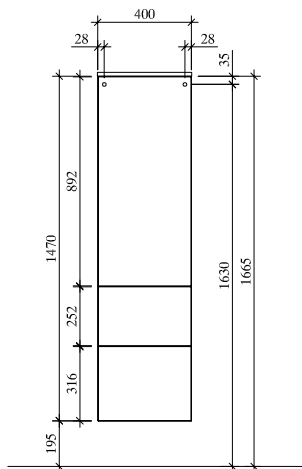

DMTT6F

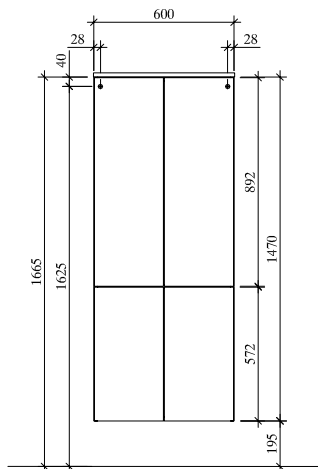

DMTAA6F

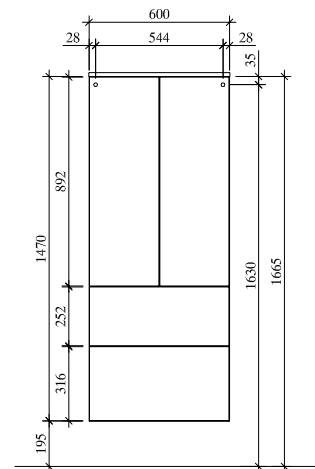

DHTST4_

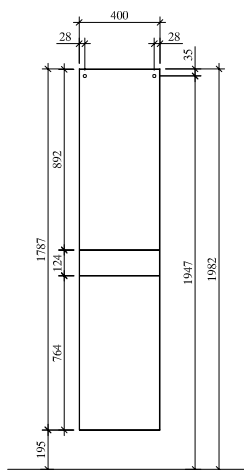

DHTAAA4_

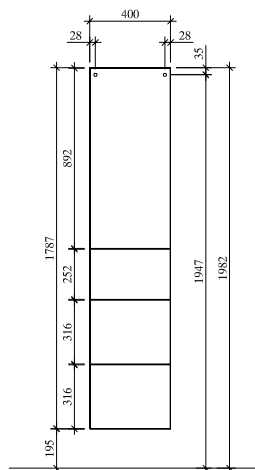

DHTT3_ DHTW4_
DHTT4_ DHPP4_
DHFTT4_ DHFPP4_

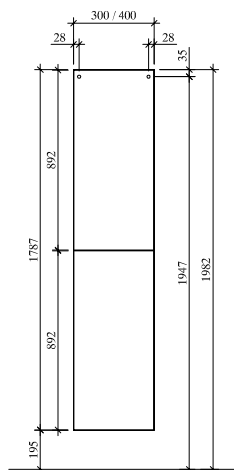

DHBT4F

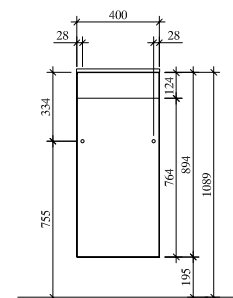

DOT4

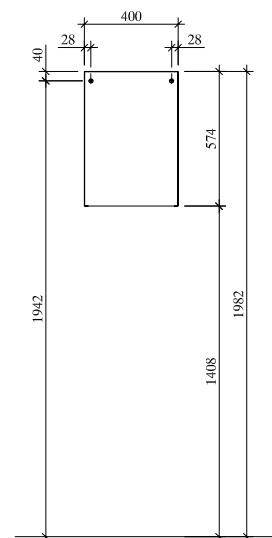

DHBT3F DHBT4F
DHBT4F DHBW4F

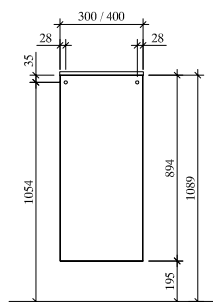

DHKBST4

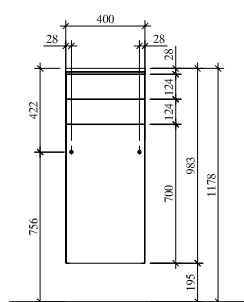

DUT4F

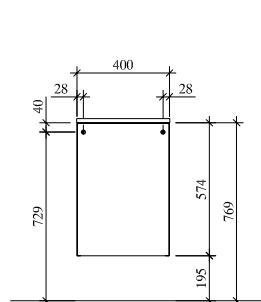

! Achtung: Die Montage muss durch fachkundige Personen erfolgen. Der Untergrund zur Wandbefestigung ist vor Montage zu prüfen. Bitte wählen Sie entsprechend das geeignete Befestigungsmaterial. Fehlerhafte Montagen können das Möbel beschädigen oder dessen Funktion dauerhaft beeinträchtigen. Für Sach- und Personenschäden übernehmen wir im Falle einer unsachgemäßen Montage keine Haftung.
 Attention: Assembly must be carried out by skilled personnel. The subsurface for the wall mounting must be checked before assembly. Please select a suitable mounting material. Faulty assembly can damage furniture or permanently impair its function. We will not be held responsible for damage to material or persons in the case of improper assembly.