

Mineralmarmor Waschtisch weiß alpin Glanz marble minerals washbasin gloss alpine white

 ≈ Beckenmaße in cm (BxHxT)
basin dimensions in cm (WxHxD)

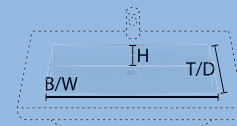

MWIDE8 |  68 x 12 x 30 cm



MWIDE10 |  68 x 12 x 30 cm



MWIDE12D |  56 x 12 x 30 cm



Detailfoto

Mineralmarmor Glanz/gloss marble minerals

PG1



weiß alpin Glanz
gloss alpine white
ID69

PG2



granit weiß
white granite
ID74

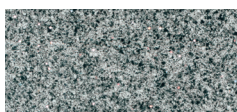

granit grau
grey granite
ID73

CH-Preise exkl. MwSt

Keramik Waschtisch weiß alpin Glanz (IDK)
 ceramic washbasin gloss alpine white (IDK)

 ≈ Beckenmaße in cm (BxHxT)
 basin dimensions in cm (WxHxD)

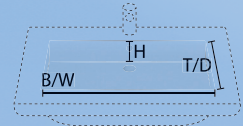

KWIDE8



KWIDE10

alle Becken/all basins =  58 x 11,5 x 31cm



Detailfoto





Befestigungsmaterial für Keramikwaschtisch MONK-4
MONK-4 fastening material for ceramic washbasin

ACHTUNG: Montage nur durch einen zertifizierten Monteur/Installateur – kein Garantieanspruch bei unsachgemäßer Montage. Befestigungsmaterial für Standard-Keramikwaschtisch (2 Stockschrauben M10x120 inkl. Dübel für massive Steinwand, bei anderen Wandbeschaffenheiten muss der Dübel entsprechend angepasst werden)





NB: Installation only by certified installer – no warranty claim after incorrect installation. Fixing material for standard ceramic basins (2 hanger bolts M10x120 incl. rawl plugs for massive masonry wall, for other wall characteristics, an adapted rawl plug must be chosen)

Schränke/cabinets IDEA

Frontfarben/front colours

Dickkante/thick edge	Lacklaminat mit Dickkante/paint laminate with thick edge
<p>286</p>  <p>weiß Seidenglanz silk gloss white IDM_</p>	<p>457</p>  <p>weiß Lacklaminat Glanz white paint gloss laminate IDY_</p>
<p>464</p>  <p>Kastanie Trüffel Nachbildung truffle chestnut finish IDR_</p>	<p>454</p>  <p>anthrazit Lacklaminat Glanz anthracite paint gloss laminate IDX_</p>
<p>261</p>  <p>Eiche natur Dickkante Nachbildung nature oak thick edge IDL_</p>	

Korpusfarben/basic shell colours

PG 1	PG 2
<p>286</p>  <p>weiß Seidenglanz silk gloss white E/ID86</p>	<p>457</p>  <p>weiß Lacklaminat Glanz white paint gloss laminate Y/ID57</p>
<p>464</p>  <p>Kastanie Trüffel Nachbildung truffle chestnut finish Z/ID64</p>	<p>454</p>  <p>anthrazit Lacklaminat Glanz anthracite paint gloss laminate X/ID54</p>
<p>261</p>  <p>Eiche natur Dickkante Nachbildung nature oak thick edge L/ID61</p>	

! BITTE BEACHTEN: Die Front-/Korpuskombination „FRONT Lacklaminat mit Dickkante (Variante: 457/454)“ mit „Korpus PG1 (Variante: 286/464/261)“ wird zu PG2 abgerechnet.

Griffleiste/handle bar



Alu matt
matt alu

Schubkästen und Auszüge *drawers and extensions*



Die neuen Schubkästen und Auszüge mit hervorragenden Laufeigenschaften und einem stabilen Vollauszug als Doppelwandstahlzarge mit Selbsteinzug, sowie integrierter Dämpfung sind in den Programmen AZURE, IDEA, JOICE und LOOP enthalten.





The new drawers and pull-outs with excellent running characteristics and a solid double wall steel frame for full pull-out and self-closing, as well as integrated damping are all part of the new programs AZURE, IDEA, JOICE and LOOP.

Lichtfarben *luminous colours*

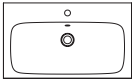

Viele Artikel sind zwischen 2 Lichtfarben (Tageslicht und Wohlfühllicht) umschaltbar.
Sehen Sie hierzu die Beschreibungen der einzelnen Artikel in den Programmen AZURE, IDEA, JOICE und LOOP.

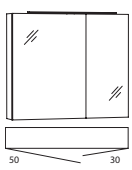
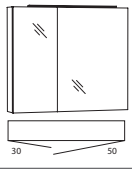
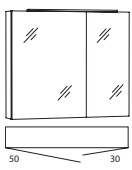
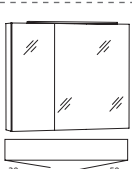
*A lot of articles have 2 light colours (natural light and warm light) which are switchable.
See declaration of articles for the programs AZURE, IDEA, JOICE and LOOP.*



Beschreibung Description	Maße in cm Dimensions in cm			Artikel-Nr. Article no.	Türanschlag	Identnummer ID number	
	B/W	H	T/D			PG1 weiß alpin/gloss white	PG2 granit/granite
 <p>Mineralmarmor-Waschtisch inkl. Überlauf</p> <p><i>marble minerals washbasin incl. overflow</i></p>	80,5	1,5	45	MWIDE8		543.--	679.--
 <p>Waschtisch-Unterschrank 1 Auszug</p> <p><i>washbasin base cabinet 1 extension</i></p>	76	47,8	44,5	IWMIBA8		511.--	581.--
 <p>Waschtisch-Unterschrank 1 Auszug, inkl. LED-Beleuchtung 7,3 W in der Griffleiste umschaltbar in 2 Lichtfarben EEK A-A++</p> <p><i>washbasin base cabinet 1 extension, incl. LED lighting 7,3 W in the handle bar two switchable luminous colours EEC A-A++</i></p>	76	47,8	44,5	IWMIBAL8 LED		676.--	746.--
 <p>Spiegelschrank, 2 vollflächig verspiegelte Türen, 2 Glaseinlegeböden, LED Beleuchtung LL74 7,0 W inkl. Schalter/Steckdose EEK A-A++ Nur in 6000 Kelvin (Tageslicht) erhältlich</p> <p><i>mirror cabinet, 2 full mirrored doors 2 glass shelves, LED lighting LL74 7,0 W incl. switch/socket EEC A-A++ only available in 6000 kelvin (natural light)</i></p>	80	68,2	13,6	SLLD8L		806.--	
 <p><i>mirror cabinet, 2 full mirrored doors 2 glass shelves, LED lighting LL74 7,0 W incl. switch/socket EEC A-A++ only available in 6000 kelvin (natural light)</i></p>				SLLD8R			
 <p>Spiegelschrank, 2 vollflächig verspiegelte Türen, 2 Glaseinlegeböden, LED Beleuchtung FLS60 10,8 W inkl. Schalter/Steckdose umschaltbar in 2 Lichtfarben EEK A-A++</p> <p><i>mirror cabinet, 2 full mirrored doors, 2 glass shelves, LED lighting FLS60 10,8 W incl. switch/socket two switchable luminous colours EEC A-A++</i></p>	80	68,2	13,6	SFLB8L		1062.--	
 <p><i>mirror cabinet, 2 full mirrored doors, 2 glass shelves, LED lighting FLS60 10,8 W incl. switch/socket two switchable luminous colours EEC A-A++</i></p>				SFLB8R			
 <p>Spiegelpaneel LED Beleuchtung FLS60 10,8 W inkl. Schalter umschaltbar in 2 Lichtfarben EEK A-A++</p> <p><i>mirror panel, LED lighting FLS60 10,8 W incl. switch two switchable luminous colours EEC A-A++</i></p>	80	68,2	2,8	SPFLB8		836.--	

EEK/EEC=Energieeffizienzklasse/energy efficiency category

Beschreibung Description	Maße in cm Dimensions in cm			Artikel-Nr. Article no.	Türanschlag	Identnummer ID number
	B/W	H	T/D			

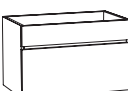
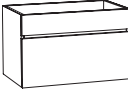

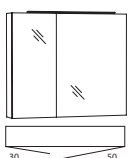

	Keramik-Waschtisch inkl. Überlauf und Befestigungsmaterial <i>ceramic washbasin incl. overflow and fastener</i>	80	3	45,5	KWIDE8		410.--
---	---	----	---	------	--------	--	---------------

							PG1 Dickkante/ thick edge	PG2 Lacklaminat mit Dick- kante/paint laminate with thick edge
	Waschtisch-Unterschrank 1 Auszug <i>washbasin base cabinet 1 extension</i>	76	47,8	44,5	IWMIBA8		511.--	581.--
	Waschtisch-Unterschrank 1 Auszug, inkl. LED-Beleuchtung 7,3 W in der Griffleiste umschaltbar in 2 Lichtfarben EEK A-A++ <i>washbasin base cabinet 1 extension, incl. LED lighting 7,3 W in the handle bar two switchable luminous colours EEC A-A++</i>	76	47,8	44,5	IWMIBAL8 LED		676.--	746.--

	Spiegelschrank, 2 vollflächig verspiegelte Türen, 2 Glaseinlegeböden, LED Beleuchtung LL74 7,0 W inkl. Schalter/Steckdose EEK A-A++ Nur in 6000 Kelvin (Tageslicht) erhältlich <i>mirror cabinet, 2 full mirrored doors 2 glass shelves, LED lighting LL74 7,0 W incl. switch/socket EEC A-A++ only available in 6000 kelvin (natural light)</i>	80	68,2	13,6	SLLD8L		806.--
							
	Spiegelschrank, 2 vollflächig verspiegelte Türen, 2 Glaseinlegeböden, LED Beleuchtung FLS60 10,8 W inkl. Schalter/Steckdose umschaltbar in 2 Lichtfarben EEK A-A++ <i>mirror cabinet, 2 full mirrored doors, 2 glass shelves, LED lighting FLS60 10,8 W incl. switch/socket two switchable luminous colours EEC A-A++</i>	80	68,2	13,6	SFLB8L		1062.--
							

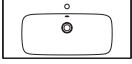
	Spiegelpanel LED Beleuchtung FLS60 10,8 W inkl. Schalter umschaltbar in 2 Lichtfarben EEK A-A++ <i>mirror panel, LED lighting FLS60 10,8 W incl. switch two switchable luminous colours EEC A-A++</i>	80	68,2	2,8	SPFLB8		836.--
---	--	----	------	-----	--------	--	---------------

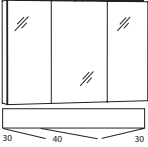
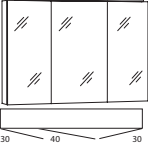

EEK/EEC=Energieeffizienzklasse/energy efficiency category

Beschreibung <i>Description</i>	Maße in cm <i>Dimensions in cm</i>			Artikel-Nr. <i>Article no.</i>	Türanschlag	Identnummer <i>ID number</i>	
	B/W	H	T/D			PG1 <i>weiß alpin/gloss white</i>	PG2 <i>granit/granite</i>
 <p>Mineralmarmor-Waschtisch inkl. Überlauf <i>marble minerals washbasin incl. overflow</i></p>	100,5	1,5	45	MWIDE10		623.--	778.--
 <p>Waschtisch-Unterschrank 1 Auszug <i>washbasin base cabinet 1 extension</i></p>	96	47,8	44,5	IWMIBA10		592.--	703.--
 <p>Waschtisch-Unterschrank 1 Auszug, inkl. LED-Beleuchtung 9,3 W in der Griffleiste umschaltbar in 2 Lichtfarben EEK A-A++ <i>washbasin base cabinet 1 extension, incl. LED lighting 9,3 W in the handle bar two switchable luminous colours EEC A-A++</i></p>	96	47,8	44,5	IWMIBAL10 LED		774.--	885.--
 <p>Spiegelschrank, 3 vollflächig verspiegelte Türen, 4 Glaseinlegeböden, LED Beleuchtung LL94 8,9 W inkl. Schalter/Steckdose EEK A-A++ Nur in 6000 Kelvin (Tageslicht) erhältlich <i>mirror cabinet, 3 full mirrored doors 4 glass shelves, LED lighting LL94 8,9 W incl. switch/socket EEC A-A++ only available in 6000 kelvin (natural light)</i></p>	100	68,2	13,6	SLLD10		963.--	
 <p>Spiegelschrank, 3 vollflächig verspiegelte Türen, 4 Glaseinlegeböden, LED Beleuchtung FLS90 17,3 W inkl. Schalter/Steckdose umschaltbar in 2 Lichtfarben EEK A-A++ <i>mirror cabinet, 3 full mirrored doors 4 glass shelves, LED lighting FLS90 17,3 W incl. switch/socket two switchable luminous colours EEC A-A++</i></p>	100	68,2	13,6	SFLB10		1253.--	
 <p>Spiegelpaneel LED Beleuchtung FLS90 17,3 W inkl. Schalter umschaltbar in 2 Lichtfarben EEK A-A++ <i>mirror panel, LED lighting FLS90 17,3 W incl. switch two switchable luminous colours EEC A-A++</i></p>	100	68,2	2,8	SPFLB10		866.--	

 EEK/EEC=Energieeffizienzklasse/*energy efficiency category*

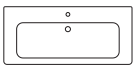
Beschreibung Description	Maße in cm Dimensions in cm			Artikel-Nr. Article no.	Türanschlag	Identnummer ID number
	B/W	H	T/D			

	Keramik-Waschtisch inkl. Überlauf und Befestigungsmaterial <i>ceramic washbasin incl. overflow and fastener</i>	100	3	45,5	KWIDE10		489.--
---	---	-----	---	------	---------	--	---------------

							PG1 Dickkante/ thick edge	PG2 Lacklaminat mit Dick- kante/paint laminate with thick edge
	Waschtisch-Unterschrank 1 Auszug <i>washbasin base cabinet 1 extension</i>	96	47,8	44,5	IWMIBA10		592.--	703.--
	Waschtisch-Unterschrank 1 Auszug, inkl. LED-Beleuchtung 9,3 W in der Griffleiste umschaltbar in 2 Lichtfarben EEK A-A++ <i>washbasin base cabinet 1 extension, incl. LED lighting 9,3 W in the handle bar two switchable luminous colours EEC A-A++</i>	96	47,8	44,5	IWMIBAL10 LED		774.--	885.--

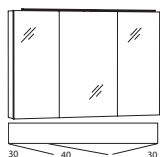
	Spiegelschrank, 3 vollflächig verspiegelte Türen, 4 Glaseinlegeböden, LED Beleuchtung LL94 8,9 W inkl. Schalter/Steckdose EEK A-A++ Nur in 6000 Kelvin (Tageslicht) erhältlich <i>mirror cabinet, 3 full mirrored doors 4 glass shelves, LED lighting LL94 8,9 W incl. switch/socket EEC A-A++ only available in 6000 kelvin (natural light)</i>	100	68,2	13,6	SLLD10		963.--
--	---	-----	------	------	--------	--	---------------

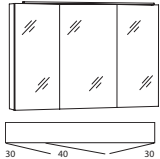
	Spiegelschrank, 3 vollflächig verspiegelte Türen, 4 Glaseinlegeböden, LED Beleuchtung FLS90 17,3 W inkl. Schalter/Steckdose umschaltbar in 2 Lichtfarben EEK A-A++ <i>mirror cabinet, 3 full mirrored doors 4 glass shelves, LED lighting FLS90 17,3 W incl. switch/socket two switchable luminous colours EEC A-A++</i>	100	68,2	13,6	SFLB10		1253.--
--	--	-----	------	------	--------	--	----------------

	Spiegelpaneel LED Beleuchtung FLS90 17,3 W inkl. Schalter umschaltbar in 2 Lichtfarben EEK A-A++ <i>mirror panel, LED lighting FLS90 17,3 W incl. switch two switchable luminous colours EEC A-A++</i>	100	68,2	2,8	SPFLB10		866.--
--	---	-----	------	-----	---------	--	---------------

EEK/EEC=Energieeffizienzklasse/energy efficiency category

Beschreibung <i>Description</i>	Maße in cm <i>Dimensions in cm</i>			Artikel-Nr. <i>Article no.</i>	Türanschlag	Identnummer <i>ID number</i>	
	B/W	H	T/D				

						PG1 weiß alpin/gloss white	PG2 granit/granite
	Mineralmarmor-Doppel-Waschtisch inkl. Überlauf <i>marble minerals double washbasin incl. overflow</i>	120,5	1,5	45	MWIDE12D	814.--	1017.--

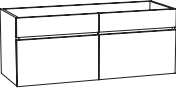
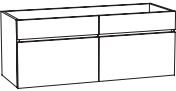

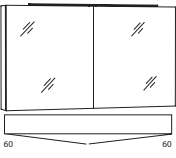
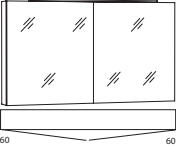
						PG1 Dickkante/ thick edge	PG2 Lacklaminat mit Dick- kante/paint laminate with thick edge
	Waschtisch-Unterschrank 2 Auszüge <i>washbasin base cabinet 2 extensions</i>	120	47,8	44,5	IWMIBAA12	909.--	1094.--
	Waschtisch-Unterschrank 2 Auszüge, inkl. LED-Beleuchtung 11,5 W in der Griffleiste umschaltbar in 2 Lichtfarben EEK A-A++ <i>washbasin base cabinet 2 extensions, incl. LED lighting 11,5 W in the handle bar two switchable luminous colours EEC A-A++</i>	120	47,8	44,5	IWMIBAAL12 LED	1139.--	1324.--

	Spiegelschrank, 2 vollflächig verspiegelte Türen, 4 Glaseinlegeböden, LED Beleuchtung LL94 8,9 W inkl. Schalter/Steckdose EEK A-A++ Nur in 6000 Kelvin (Tageslicht) erhältlich <i>mirror cabinet, 2 full mirrored doors 4 glass shelves, LED lighting LL94 8,9 W incl. switch/socket EEC A-A++ only available in 6000 kelvin (natural light)</i>	120	68,2	13,6	SLLD12		979.--
	Spiegelschrank, 2 vollflächig verspiegelte Türen, 4 Glaseinlegeböden, LED Beleuchtung FLS90 17,3 W inkl. Schalter/Steckdose umschaltbar in 2 Lichtfarben EEK A-A++ <i>mirror cabinet, 2 full mirrored doors 4 glass shelves, LED lighting FLS90 17,3 W incl. switch/socket two switchable luminous colours EEC A-A++</i>	120	68,2	13,6	SFLB12		1273.--

	Spiegelpaneel LED Beleuchtung FLS90 17,3 W inkl. Schalter umschaltbar in 2 Lichtfarben EEK A-A++ <i>mirror panel, LED lighting FLS90 17,3 W incl. switch two switchable luminous colours EEC A-A++</i>	120	68,2	2,8	SPFLB12		894.--
---	---	-----	------	-----	---------	--	---------------



EEK/EEC=Energieeffizienzklasse/*energy efficiency category*

Beschreibung Description	Maße in cm Dimensions in cm			Artikel-Nr. Article no.	Türanschlag	Identnummer ID number
	B/W	H	T/D			
 Handtuchhalter verchromt (Befestigung am Schrank) <i>chromed towel rail (fastening on the cabinet)</i>	5	2,5	40	MHH		126.--
 Handtuchhalter 2-armig (Befestigung am Schrank) ausziehbar <i>towel rail 2-arms (fastening on the cabinet) pull out</i>	10,5	4	32,5/ 50	HH233		76.--
 Handtuchhalter 1-armig (Befestigung am Schrank) ausziehbar <i>towel rail 1-arm (fastening on the cabinet) pull out</i>	10,5	4	32,5/ 50	HH133		60.--
 Handtuchhalter 1-armig (Befestigung am Schrank) <i>towel rail 1-arm (fastening on the cabinet)</i>	5	1	33	HHF133		33.--
 Inneneinteilung für 60 cm Auszug IWMIBAA(L)12 <i>internal subdivision for 60 cm extension IWMIBAA(L)12</i>				IEG60		97.--
 Inneneinteilung für 80 cm Auszug IWMIBA(L)8 <i>internal subdivision for 80 cm extension IWMIBA(L)8</i>				IEG76		97.--
 Inneneinteilung für 100 cm Auszug IWMIBA(L)10 <i>internal subdivision for 100 cm extension IWMIBA(L)10</i>				IEG96		97.--
 Innenauszug für Beistellschränke 40 cm <i>internal drawer for side cabinets 40 cm</i>				ISG40		140.--
 Montageschiene inkl. Befestigungsmaterial <i>mounting rail incl. fastening material</i>	210			MS210-4		89.--

Beschreibung Description	Maße in cm Dimensions in cm			Artikel-Nr. Article no.	Türanschlag	Identnummer ID number
	B/W	H	T/D			
 <p>Spiegelschrank-Unterbauleuchtung 3W LED EEK A-A++ (für Spiegelschrank ab 80 cm Breite) Nur in 6000 Kelvin (Tageslicht) erhältlich</p> <p><i>base lighting for mirror cabinet 3W LED EEC A-A++ (for mirror cabinet ex 80 cm width) only available in 6000 kelvin (natural light)</i></p>	70			WTB70		142.--
 <p>Spiegelschrank-Unterbauleuchtung 4,3W LED EEK A-A++ (für Spiegelschrank ab 120 cm Breite) Nur in 6000 Kelvin (Tageslicht) erhältlich</p> <p><i>base lighting for mirror cabinet 4,3W LED EEC A-A++ (for mirror cabinet ex 120 cm width) only available in 6000 kelvin (natural light)</i></p>	110			WTB110		205.--
 <p>LED-Unterbauleuchte (2er Set) 6,0 W EEK A-A++ Nur in 4000 Kelvin (Wohlfühllicht) erhältlich</p> <p><i>LED base lighting (2 pcs / unit) 6,0 W EEC A-A++ only available in 4000 kelvin (warm light)</i></p>	10		10	WTBF210		270.--

EEK/EEC=Energieeffizienzklasse/energy efficiency category

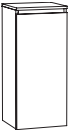
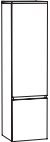
IDEA Beistellschränke/ *side cabinets*

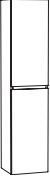
Beschreibung <i>Description</i>	Maße in cm <i>Dimensions in cm</i>			Artikel-Nr. <i>Article no.</i>	Türanschlag	Identnummer <i>ID number</i>	
	B/W	H	T/D			PG1 Dickkante/ <i>thick edge</i>	PG2 Lacklaminat mit Dick- kante/ <i>paint laminate</i> with thick edge
 <p>Highboard inkl. Abdeckplatte 1 Tür 2 Glaseinlegeböden <i>high cabinet incl. top</i> <i>1 door</i> <i>2 glass shelves</i></p>	40	91,2	34,8	IHBT4F	L/R	366.--	503.--
 <p>Highboard inkl. Abdeckplatte 1 Tür/Wäschekippe <i>high cabinet incl. top</i> <i>1 door/linen bin</i></p>	40	91,2	34,8	IHBW4F		421.--	558.--
 <p>Mittelschrank inkl. Abdeckplatte 2 Türen 3 Glaseinlegeböden <i>medium cabinet incl. top</i> <i>2 doors</i> <i>3 glass shelves</i></p>	40	148,8	34,8	IMTT4F	L/R	478.--	637.--
 <p>Hochschrank 2 Türen 4 Glaseinlegeböden <i>tower cabinet</i> <i>2 doors</i> <i>4 glass shelves</i></p>	40	178,7	34,8	IHTT4	L/R	569.--	720.--
 <p>Hochschrank 1 Tür / 1 Wäschekippe 2 Glaseinlegeböden <i>tower cabinet</i> <i>1 door / 1 linen bin</i> <i>2 glass shelves</i></p>	40	178,7	34,8	IHTW4	L/R	601.--	752.--

SFLB8L
SLLD8L

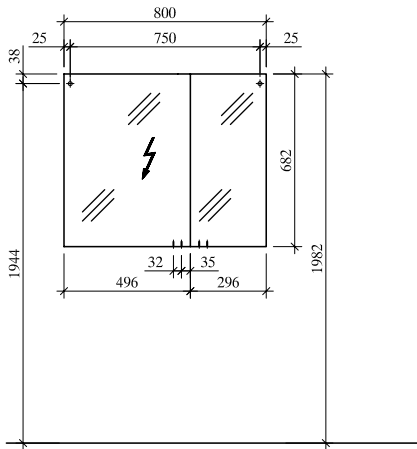

SFLB8R
SLLD8R

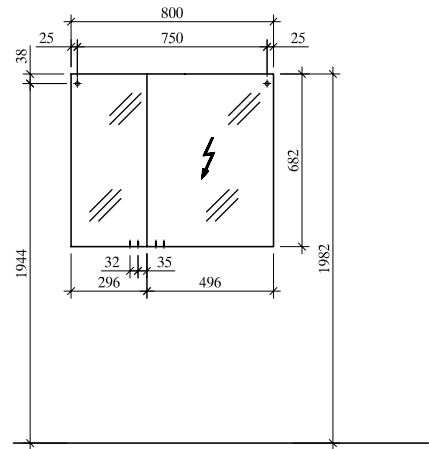

SFLB10
SLLD10

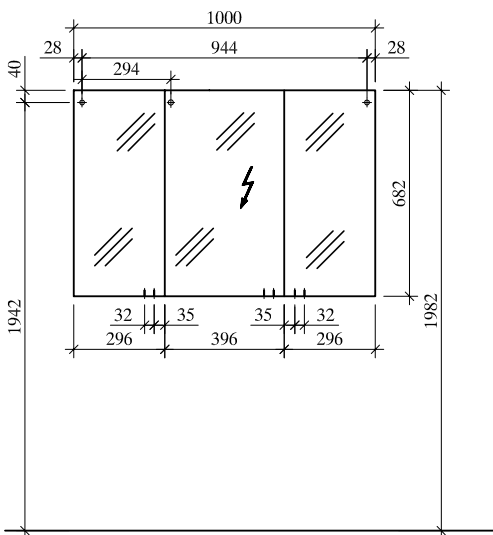

SFLB12
SLLD12

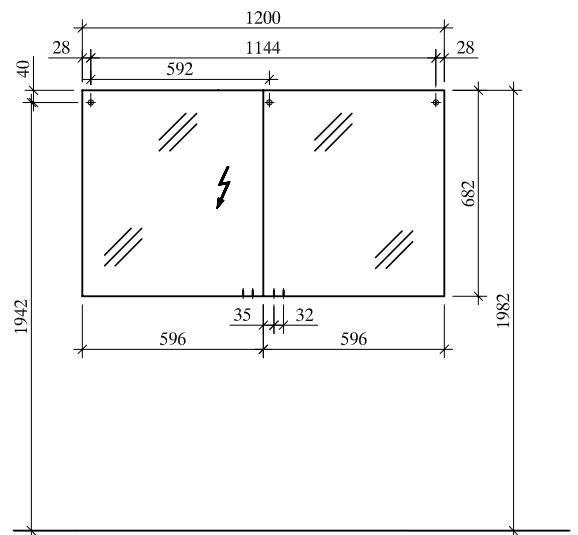

! Achtung: Die Montage muss durch fachkundige Personen erfolgen. Der Untergrund zur Wandbefestigung ist vor Montage zu prüfen. Bitte wählen Sie entsprechend das geeignete Befestigungsmaterial. Fehlerhafte Montagen können das Möbel beschädigen oder dessen Funktion dauerhaft beeinträchtigen. Für Sach- und Personenschäden übernehmen wir im Falle einer unsachgemäßen Montage keine Haftung.
 Attention: Assembly must be carried out by skilled personnel. The subsurface for the wall mounting must be checked before assembly. Please select a suitable mounting material. Faulty assembly can damage furniture or permanently impair its function. We will not be held responsible for damage to material or persons in the case of improper assembly.

SPFLB8

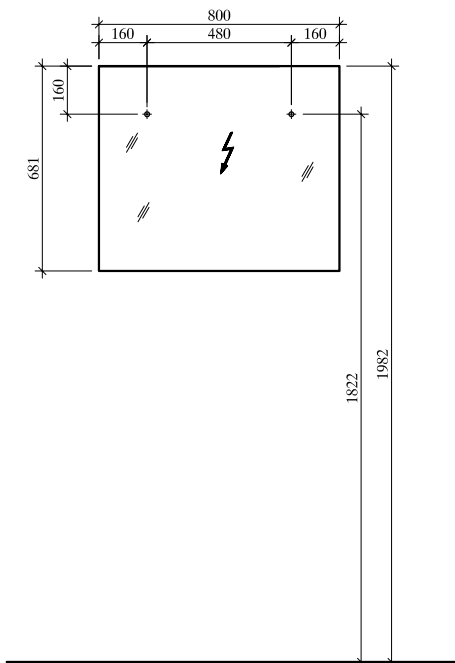

SPFLB10

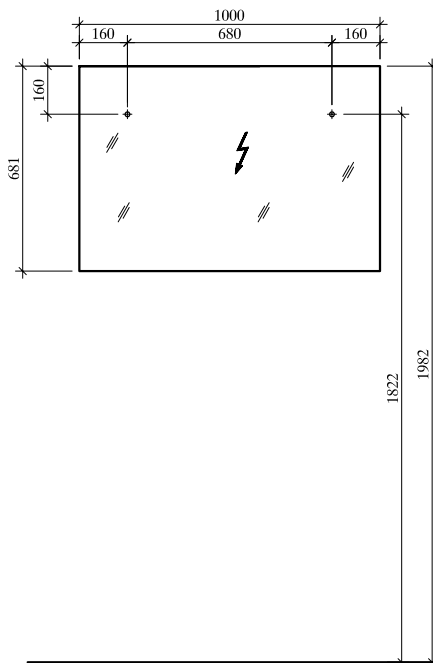

SPFLB12

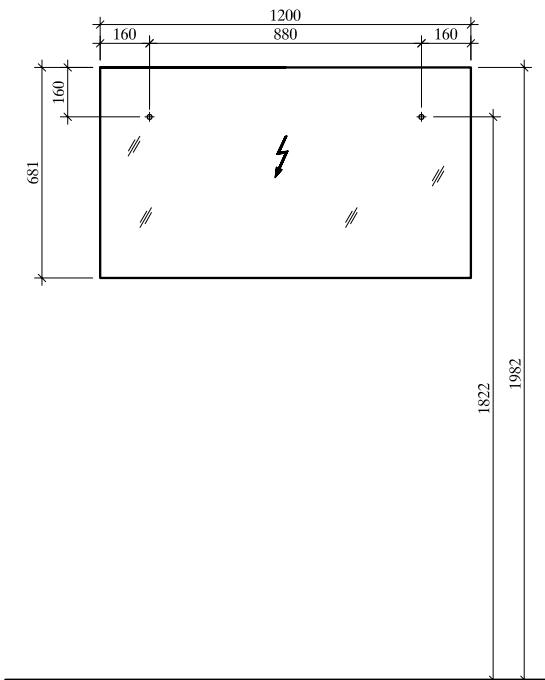

! Achtung: Die Montage muss durch fachkundige Personen erfolgen. Der Untergrund zur Wandbefestigung ist vor Montage zu prüfen. Bitte wählen Sie entsprechend das geeignete Befestigungsmaterial. Fehlerhafte Montagen können das Möbel beschädigen oder dessen Funktion dauerhaft beeinträchtigen. Für Sach- und Personenschäden übernehmen wir im Falle einer unsachgemäßen Montage keine Haftung.
 Attention: Assembly must be carried out by skilled personnel. The subsurface for the wall mounting must be checked before assembly. Please select a suitable mounting material. Faulty assembly can damage furniture or permanently impair its function. We will not be held responsible for damage to material or persons in the case of improper assembly.

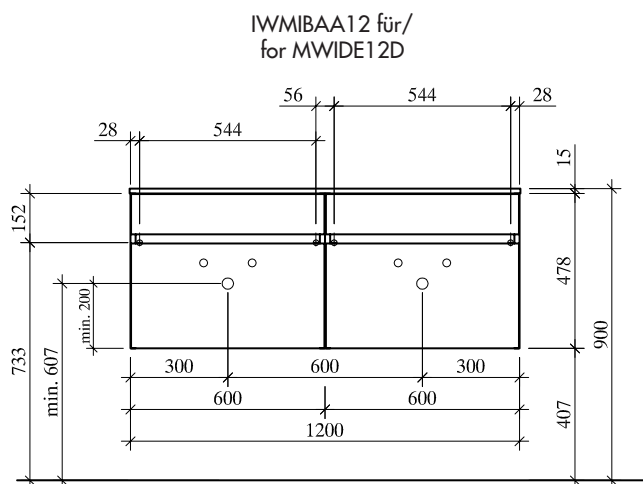
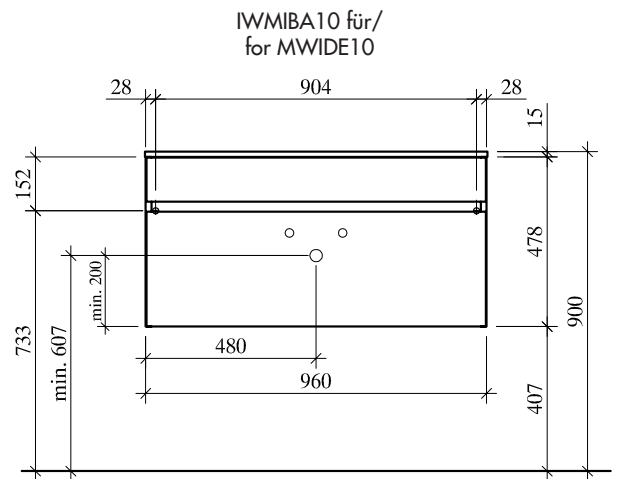
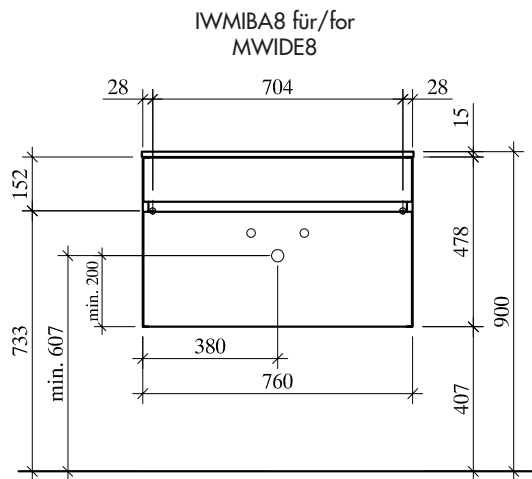
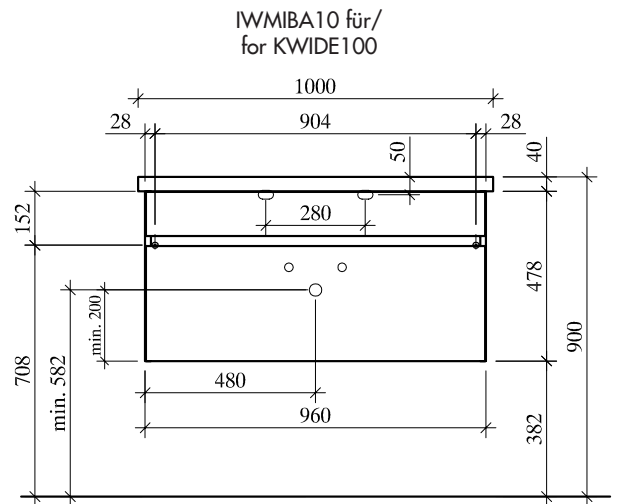
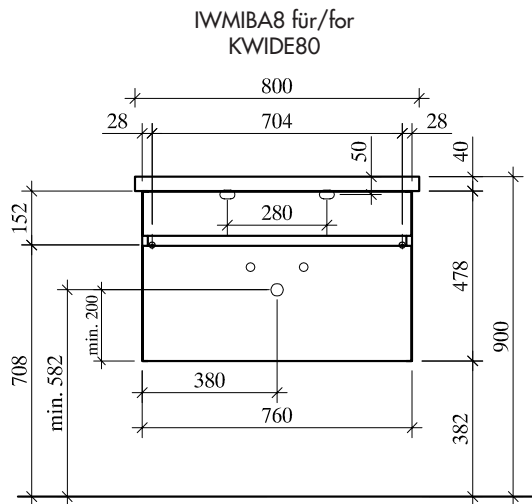

! Achtung: Die Montage muss durch fachkundige Personen erfolgen. Der Untergrund zur Wandbefestigung ist vor Montage zu prüfen. Bitte wählen Sie entsprechend das geeignete Befestigungsmaterial. Fehlerhafte Montagen können das Möbel beschädigen oder dessen Funktion dauerhaft beeinträchtigen. Für Sach- und Personenschäden übernehmen wir im Falle einer unsachgemäßen Montage keine Haftung.
 Attention: Assembly must be carried out by skilled personnel. The subsurface for the wall mounting must be checked before assembly. Please select a suitable mounting material. Faulty assembly can damage furniture or permanently impair its function. We will not be held responsible for damage to material or persons in the case of improper assembly.

IMTT4F

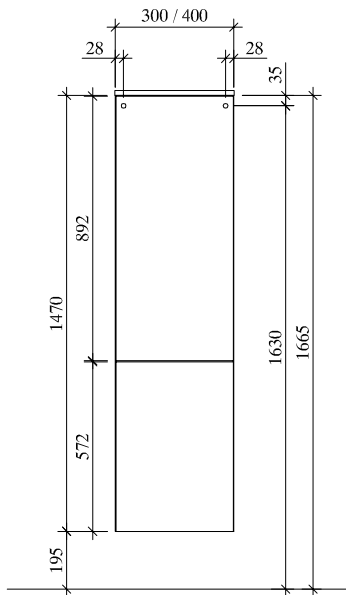

IHTT4
IHTW4

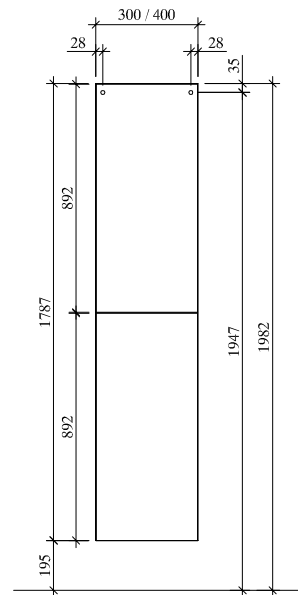

IHBT4F
IHBW4F

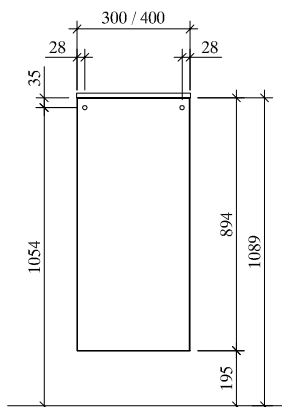

! Achtung: Die Montage muss durch fachkundige Personen erfolgen. Der Untergrund zur Wandbefestigung ist vor Montage zu prüfen. Bitte wählen Sie entsprechend das geeignete Befestigungsmaterial. Fehlerhafte Montagen können das Möbel beschädigen oder dessen Funktion dauerhaft beeinträchtigen. Für Sach- und Personenschäden übernehmen wir im Falle einer unsachgemäßen Montage keine Haftung.

Attention: Assembly must be carried out by skilled personnel. The subsurface for the wall mounting must be checked before assembly. Please select a suitable mounting material. Faulty assembly can damage furniture or permanently impair its function. We will not be held responsible for damage to material or persons in the case of improper assembly.