

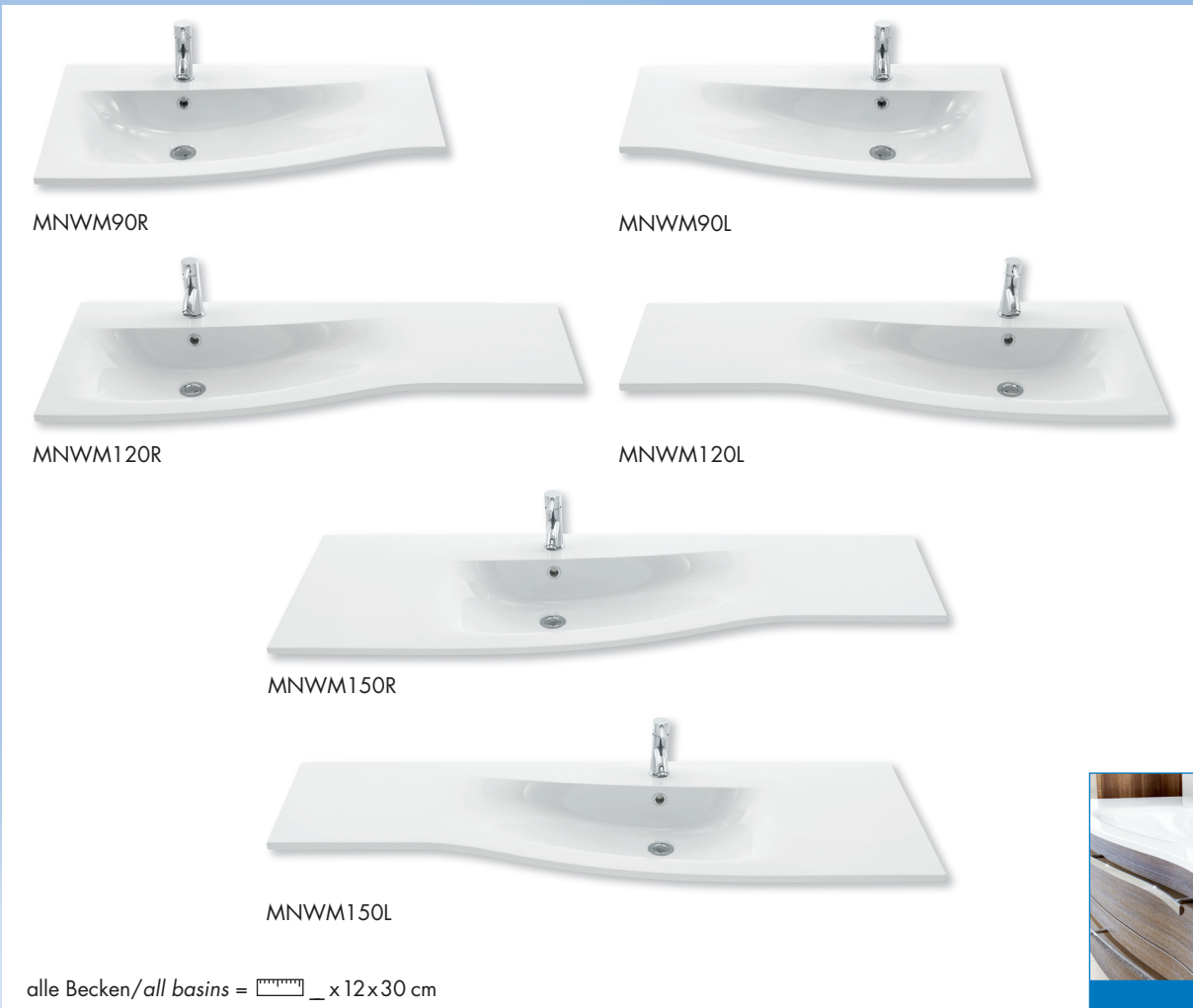

Mineralmarmor Waschtisch weiß alpin Glanz (MN69)
 marble minerals washbasin gloss alpine white (MN69)

 ≈ Beckenmaße in cm (BxHxT)
 basin dimensions in cm (WxHxD)

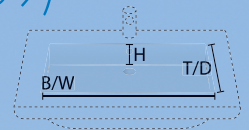





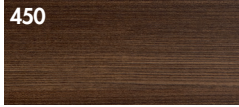

alle Becken/all basins =  x 12x30 cm

Schränke/cabinets MOTION

Frontfarben/front colours

MDF-foliiert/MDF-coated

	449 Kastanie graphit Nachbildung <i>graphite chestnut finish</i> MNC_		450 Kastanie maron Nachbildung <i>maroon chestnut finish</i> MNM_
	467 Eiche natur Nachbildung <i>nature oak</i> MNV_		463 Kastanie titan Nachbildung <i>titanium chestnut finish</i> MNT_
	458 Robinie dunkel Nachbildung <i>robinia dark</i> MNJ_		961 weiß Glanz <i>gloss white</i> MNG_
	443 Kastanie hell Nachbildung <i>light chestnut finish</i> MNK_		438 anthrazit Glanz <i>gloss anthracite</i> MNF_

Korpusfarben/basic shell colours

PG 2

	449 Kastanie graphit Nachbildung <i>graphite chestnut finish</i> C/MN45		450 Kastanie maron Nachbildung <i>maroon chestnut finish</i> M/MN85
	467 Eiche natur Nachbildung <i>nature oak</i> V/MN61		463 Kastanie titan Nachbildung <i>titanium chestnut finish</i> I/MN63
	458 Robinie dunkel Nachbildung <i>robinia dark</i> J/MN58		130 Kastanie hell Nachbildung <i>light chestnut finish</i> K/MN35

PG 3

	042 weiß Glanz <i>gloss white</i> G/MN50		438 anthrazit Glanz <i>gloss anthracite</i> F/MN30
--	---	--	---

Griffe/handles



chrom Glanz inklusive
gloss chrome inclusive

Beschreibung Description	Maße in cm Dimensions in cm			Artikel-Nr. Article no.	Türanschlag	Identnummer ID number
	B/W	H	T/D			

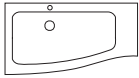
	Mineralmarmor-Waschtisch inkl. Überlauf <i>marble minerals washbasin incl. overflow</i>	90,4	2	48,5/ 35,5	MNWM90R		395.--
---	---	------	---	---------------	---------	--	---------------

							PG2 matt/matt	PG3 Glanz/gloss
	Waschtisch-Unterschrank 2 Auszüge <i>washbasin base cabinet 2 extensions</i>	90	47,8	48/ 35	MNWUG92DR		819.--	907.--

IS = Spiegeltür mit Trägerplatte 20 mm und aufgeklebtem Innenspiegel (#)/mirror doors on carrier plate 20 mm with glued inside mirror (#)
 = Doppelspiegeltür 6 mm/double sided mirror doors 6 mm

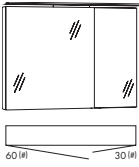
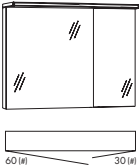
	Spiegelschrank, 2 Spiegeltüren 2 Glaseinlegeböden LED-Aufsatzleuchte FL90 15W inkl. Schalter/Steckdose EEK A–A++ <i>mirror cabinet, 2 mirror doors 2 glass shelves, top light with LED FL90 15W incl. switch/socket EEC A–A++</i>	90	68,2	13,6	SSF63	IS	849.--
				12,2	SPSF63	DS	1007.--
	Spiegelschrank, 2 Spiegeltüren 2 Glaseinlegeböden Oberboden mit LED Beleuchtung inkl. Schalter/Steckdose EEK A–A++ <i>mirror cabinet, 2 mirror doors 2 glass shelves top with LED lighting incl. switch/socket EEC A–A++</i>	90	68,2/ 70,7	13,6	SSK63	IS	893.--
				12,2	SPSK63	DS	1051.--

EEK/EEC=Energieeffizienzklasse/energy efficiency category

Beschreibung Description	Maße in cm Dimensions in cm			Artikel-Nr. Article no.	Türanschlag	Identnummer ID number
	B/W	H	T/D			

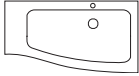
	Mineralmarmor-Waschtisch inkl. Überlauf <i>marble minerals washbasin incl. overflow</i>	90,4	2	35,5/ 48,5	MNWM90L		395.--
---	---	------	---	---------------	---------	--	---------------

							PG2 matt/matt	PG3 Glanz/gloss
	Waschtisch-Unterschrank 2 Auszüge <i>washbasin base cabinet 2 extensions</i>	90	47,8	35/ 48	MNWUG92DL		819.--	907.--

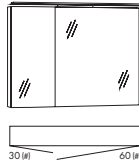
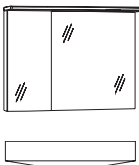

IS = Spiegeltür mit Trägerplatte 20 mm und aufgeklebtem Innenspiegel (#)/mirror doors on carrier plate 20 mm with glued inside mirror (#)
DS = Doppelspiegeltür 6 mm/double sided mirror doors 6 mm

	Spiegelschrank, 2 Spiegeltüren 2 Glaseinlegeböden LED-Aufsatzleuchte FL90 15W inkl. Schalter/Steckdose EEK A–A++ <i>mirror cabinet, 2 mirror doors 2 glass shelves, top light with LED FL90 15W incl. switch/socket EEC A–A++</i>	90	68,2	13,6	SSF36	IS	849.--
				12,2	SPSF36	DS	1007.--
	Spiegelschrank, 2 Spiegeltüren 2 Glaseinlegeböden Oberboden mit LED Beleuchtung inkl. Schalter/Steckdose EEK A–A++ <i>mirror cabinet, 2 mirror doors 2 glass shelves top with LED lighting incl. switch/socket EEC A–A++</i>	90	68,2/ 70,7	13,6	SSK36	IS	893.--
				12,2	SPSK36	DS	1051.--

EEK/EEC=Energieeffizienzklasse/energy efficiency category

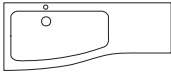
Beschreibung Description	Maße in cm Dimensions in cm			Artikel-Nr. Article no.	Türanschlag	Identnummer ID number
	B/W	H	T/D			

	Mineralmarmor-Waschtisch inkl. Überlauf <i>marble minerals washbasin incl. overflow</i>	120,4	2	48,5/ 35,5	MNWM120R		512.--
---	---	-------	---	---------------	----------	--	---------------

							PG2 matt/matt	PG3 Glanz/gloss
	Waschtisch-Unterschrank 2 Auszüge <i>washbasin base cabinet 2 extensions</i>	90	47,8	48/ 35	MNWUG92DR		819.--	907.--
	Unterschrank 1 Tür, 1 Glaseinlegeboden <i>base cabinet 1 door, 1 glass shelve</i>	30	47,8	35	MNWU30D	L/R	249.--	337.--
	Unterschrank 2 Auszüge <i>base cabinet 2 extensions</i>	30	47,8	35	MNWUA32D		410.--	497.--

IS = Spiegeltür mit Trägerplatte 20 mm und aufgeklebtem Innenspiegel (#)/mirror doors on carrier plate 20 mm with glued inside mirror (#)

DS = Doppelspiegeltür 6 mm/double sided mirror doors 6 mm

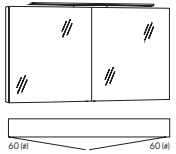
	Spiegelschrank, 2 Spiegeltüren 4 Glaseinlegeböden LED-Aufsatzleuchte FL90 15W inkl. Schalter/Steckdose EEK A–A++ <i>mirror cabinet, 2 mirror doors 4 glass shelves, top light with LED FL90 15W incl. switch/socket EEC A–A++</i>	120	68,2	13,6	SSF66	IS	936.--
				12,2	SPSF66	DS	1121.--

A = Regal (korpusfarbig) mit Glasablageböden/shelf (basic shell coloured) with glass shelves

B = Regal mit Spiegel und Glasablageböden (LED)/shelf with mirror and glass shelves (LED)

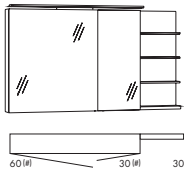
							A	B
	Spiegelschrank, 2 Spiegeltüren 2 Glaseinlegeböden Regal (!) R, LED-Aufsatzleuchte FL90 15W inkl. Schalter/Steckdose EEK A–A++ <i>mirror cabinet, 2 mirror doors 2 glass shelves shelf (!) R, top light with LED FL90 15W incl. switch/socket EEC A–A++</i>	120	68,2	13,6	SSF63R	IS	971.--	
				12,2	SPSF63R	DS	1129.--	
				13,6	SSF63RLS	IS	1287.--	
				12,2	SPSF63RLS	DS	1445.--	



EEK/EEC=Energieeffizienzklasse/energy efficiency category

MOTION »120R«

mit Oberboden inkl. LED Beleuchtungsleisten/*with top incl. LED lighting strip*

Beschreibung <i>Description</i>	Maße in cm <i>Dimensions in cm</i>			Artikel-Nr. <i>Article no.</i>	Türanschlag	Identnummer <i>ID number</i>
	B/W	H	T/D			

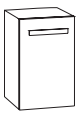
	Mineralmarmor-Waschtisch inkl. Überlauf <i>marble minerals washbasin incl. overflow</i>	120,4	2	48,5/ 35,5	MNWM120R		512.--
--	---	-------	---	---------------	----------	--	--------

							PG2 matt/matt	PG3 Glanz/gloss
	Waschtisch-Unterschrank 2 Auszüge <i>washbasin base cabinet 2 extensions</i>	90	47,8	48/ 35	MNWUG92DR		819.--	907.--
	Unterschrank 1 Tür, 1 Glaseinlegeboden <i>base cabinet 1 door, 1 glass shelf</i>	30	47,8	35	MNWU30D	L/R	249.--	337.--
	Unterschrank 2 Auszüge <i>base cabinet 2 extensions</i>	30	47,8	35	MNWUA32D		410.--	497.--

IS = Spiegeltür mit Trägerplatte 20 mm und aufgeklebtem Innenspiegel (#)/*mirror doors on carrier plate 20 mm with glued inside mirror (#)*

DS = Doppelspiegeltür 6 mm/*double sided mirror doors 6 mm*

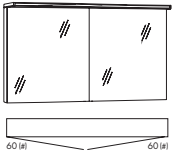
	Spiegelschrank, 2 Spiegeltüren 4 Glaseinlegeböden Oberboden m. LED-Beleuchtung inkl. Schalter/Steckdose EEK A–A++ <i>mirror cabinet, 2 mirror doors 4 glass shelves, top with LED lighting incl. switch/socket EEC A–A++</i>	120	68,2/ 70,7	13,6	SSK660R	IS	1039.--
				12,2	SPSK660R	DS	1223.--

A = Regal (korpusfarbig) mit Glasablageböden/*shelf (basic shell coloured) with glass shelves*

B = Regal mit Spiegel und Glasablageböden (LED)/*shelf with mirror and glass shelves (LED)*

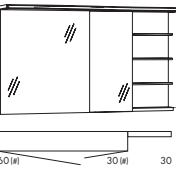
							A	B
	Spiegelschrank, 2 Spiegeltüren 2 Glaseinlegeböden, Regal (!) R, Oberboden mit LED Beleuchtung inkl. Schalter/Steckdose EEK A–A++ <i>mirror cabinet, 2 mirror doors 2 glass shelves shelf (!) R, top with LED lighting incl. switch/socket EEC A–A++</i>	120	68,2/ 70,7	13,6	SSK63R	IS	1074.--	
				12,2	SPSK63R	DS	1051.--	
				13,6	SSK63RLS	IS	1390.--	
				12,2	SPSK63RLS	DS	1548.--	

EEK/EEC=Energieeffizienzklasse/energy efficiency category

Beschreibung Description	Maße in cm Dimensions in cm			Artikel-Nr. Article no.	Türanschlag	Identnummer ID number
	B/W	H	T/D			

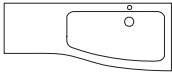
	Mineralmarmor-Waschtisch inkl. Überlauf <i>marble minerals washbasin incl. overflow</i>	120,4	2	35,5/ 48,5	MNWM120L		512.--
---	---	-------	---	---------------	----------	--	---------------

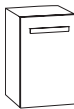
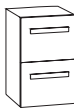
							PG2 matt/matt	PG3 Glanz/gloss
	Waschtisch-Unterschrank 2 Auszüge <i>washbasin base cabinet 2 extensions</i>	90	47,8	35/ 48	MNWUG92DL		819.--	907.--
	Unterschrank 1 Tür, 1 Glaseinlegeboden <i>base cabinet 1 door, 1 glass shelve</i>	30	47,8	35	MNWU30D	L/R	249.--	337.--
	Unterschrank 2 Auszüge <i>base cabinet 2 extensions</i>	30	47,8	35	MNWUA32D		410.--	497.--

IS = Spiegeltür mit Trägerplatte 20 mm und aufgeklebtem Innenspiegel (#)/mirror doors on carrier plate 20 mm with glued inside mirror (#)

DS = Doppelspiegeltür 6 mm/double sided mirror doors 6 mm

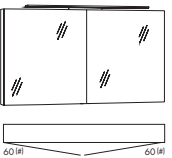
	Spiegelschrank, 2 Spiegeltüren 4 Glaseinlegeböden LED-Aufsatzleuchte FL90 15W inkl. Schalter/Steckdose EEK A–A++ <i>mirror cabinet, 2 mirror doors 4 glass shelves, top light with LED FL90 15W incl. switch/socket EEC A–A++</i>	120	68,2	13,6	SSF66	IS	936.--
				12,2	SPSF66	DS	

A = Regal (korpusfarbig) mit Glasablageböden/shelf (basic shell coloured) with glass shelves

B = Regal mit Spiegel und Glasablageböden (LED)/shelf with mirror and glass shelves (LED)

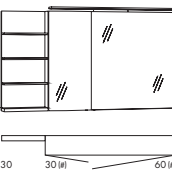
							A	B
	Spiegelschrank, 2 Spiegeltüren 2 Glaseinlegeböden Regal (!) L, LED-Aufsatzleuchte FL90 15W, inkl. Schalter/Steckdose EEK A–A++ <i>mirror cabinet, 2 mirror doors 2 glass shelves shelf (!) L, top light with LED FL90 15W incl. switch/socket EEC A–A++</i>	120	68,2	13,6	SSFR36	IS	971.--	
				12,2	SPSFR36	DS	1129.--	
				13,6	SSFR36LS	IS		1287.--
				12,2	SPSFR36LS	DS		1445.--



EEK/EEC=Energieeffizienzklasse/energy efficiency category

MOTION »120L«

mit Oberboden inkl. LED Beleuchtungsleisten/*with top incl. LED lighting strip*

Beschreibung <i>Description</i>	Maße in cm <i>Dimensions in cm</i>			Artikel-Nr. <i>Article no.</i>	Türanschlag	Identnummer <i>ID number</i>
	B/W	H	T/D			

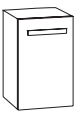
	Mineralmarmor-Waschtisch inkl. Überlauf <i>marble minerals washbasin incl. overflow</i>	120,4	2	35,5/ 48,5	MNWM120L		512.--
--	---	-------	---	---------------	----------	--	--------

							PG2 matt/matt	PG3 Glanz/gloss
	Waschtisch-Unterschrank 2 Auszüge <i>washbasin base cabinet 2 extensions</i>	90	47,8	35/ 48	MNWUG92DL		819.--	907.--
	Unterschrank 1 Tür, 1 Glaseinlegeboden <i>base cabinet 1 door, 1 glass shelve</i>	30	47,8	35	MNWU30D	L/R	249.--	337.--
	Unterschrank 2 Auszüge <i>base cabinet 2 extensions</i>	30	47,8	35	MNWUA32D		410.--	497.--

IS = Spiegeltür mit Trägerplatte 20 mm und aufgeklebtem Innenspiegel (#)/*mirror doors on carrier plate 20 mm with glued inside mirror (#)*

DS = Doppelspiegeltür 6 mm/*double sided mirror doors 6 mm*

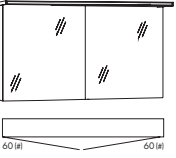
	Spiegelschrank, 2 Spiegeltüren 4 Glaseinlegeböden Oberboden m. LED-Beleuchtung inkl. Schalter/Steckdose EEK A-A++ <i>mirror cabinet, 2 mirror doors 4 glass shelves, top with LED lighting incl. switch/socket EEC A-A++</i>	120	68,2/ 70,7	13,6	SSK660L	IS	1039.--
				12,2	SPSK660L	DS	1223.--

A = Regal (korpusfarbig) mit Glasablageböden/*shelf (basic shell coloured) with glass shelves*

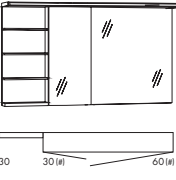

B = Regal mit Spiegel und Glasablageböden (LED)/*shelf with mirror and glass shelves (LED)*

							A	B
	Spiegelschrank, 2 Spiegeltüren 2 Glaseinlegeböden Regal (!) L, Oberboden mit LED-Beleuchtung inkl. Schalter/Steckdose EEK A-A++ <i>mirror cabinet, 2 mirror doors 2 glass shelves shelf (!) L, top with LED lighting incl. switch/socket EEC A-A++</i>	120	68,2/ 70,7	13,6	SSKR36	IS	1074.--	
				12,2	SPSKR36	DS	1232.--	
				13,6	SSKR36LS	IS	1390.--	
				12,2	SPSKR36LS	DS	1548.--	

EEK/EEC=Energieeffizienzklasse/*energy efficiency category*

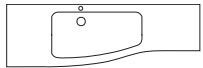
Beschreibung Description	Maße in cm Dimensions in cm			Artikel-Nr. Article no.	Türanschlag	Identnummer ID number
	B/W	H	T/D			

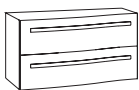
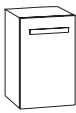
	Mineralmarmor-Waschtisch inkl. Überlauf <i>marble minerals washbasin incl. overflow</i>	150,4	2	48,5/ 35,5	MNWM150R		585.--
---	---	-------	---	---------------	----------	--	---------------

							PG2 matt/matt	PG3 Glanz/gloss
	Waschtisch-Unterschrank 2 Auszüge <i>washbasin base cabinet 2 extensions</i>	90	47,8	48/ 35	MNWUG92DR		819.--	907.--
	Unterschrank 1 Tür, 1 Glaseinlegeboden <i>base cabinet 1 door, 1 glass shelf</i>	30	47,8	35	MNWU30D	L/R	249.--	337.--
		30	47,8	48	MNWU30TD	L/R		
	Unterschrank 2 Auszüge <i>base cabinet 2 extensions</i>	30	47,8	35	MNWUA32D		410.--	497.--
		30	47,8	48	MNWUA32TD			

IS = Spiegeltür mit Trägerplatte 20 mm und aufgeklebtem Innenspiegel (#)/mirror doors on carrier plate 20 mm with glued inside mirror (#)

DS = Doppelspiegeltür 6 mm/double sided mirror doors 6 mm

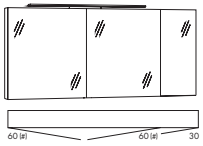
	Spiegelschrank, 3 Spiegeltüren, 6 Glaseinlegeböden, LED-Aufsatzleuchte 15W inkl. Schalter/Steckdose EEK A-A++ <i>mirror cabinet, 3 mirror doors 6 glass shelves, top light with LED 15W incl. switch/socket EEC A-A++</i>	150	68,2	13,6	SSF663	IS	1024.--
				12,2	SPSF663	DS	1235.--

A = Regal (korpusfarbig) mit Glasablageböden/shelf (basic shell coloured) with glass shelves

B = Regal mit Spiegel und Glasablageböden (LED)/shelf with mirror and glass shelves (LED)

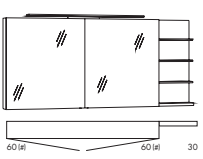
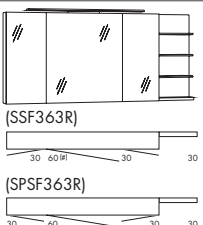
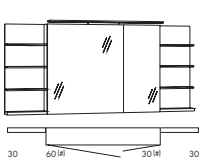
							A	B
	Spiegelschrank, 2 Spiegeltüren 4 Glaseinlegeböden, Regal (!) R, LED-Aufsatzleuchte FL90 15W inkl. Schalter/Steckdose EEK A-A++ <i>mirror cabinet, 2 mirror doors 4 glass shelves, shelf (!) R, top light with LED FL90 15W incl. switch/socket EEC A-A++</i>	150	68,2	13,6	SSF66R	IS	1059.--	
					SPSF66R	DS	1244.--	
					SSF66RLS	IS		1375.--
					SPSF66RLS	DS		1560.--
	Spiegelschrank, 3 Spiegeltüren 6 (4) Glaseinlegeböden, Regal (!) R, LED-Aufsatzleuchte FL90 15W inkl. Schalter/Steckdose EEK A-A++ <i>mirror cabinet, 3 mirror doors 6 (4) glass shelves, shelf (!) R, top light with LED FL90 15W incl. switch/socket EEC A-A++</i>	150	68,2	13,6	SSF363R	IS	1074.--	
					SPSF363R	DS	1261.--	
					SSF363RLS	IS		1390.--
					SPSF363RLS	DS		1577.--
	Spiegelschrank, 2 Spiegeltüren 2 Glaseinlegeböden, Regal (!) L+R, LED-Aufsatzleuchte FL90 15W inkl. Schalter/Steckdose EEK A-A++ <i>mirror cabinet, 2 mirror doors 2 glass shelves, shelf (!) L+R, top light with LED FL90 15W incl. switch/socket EEC A-A++</i>	150	68,2	13,6	SSFR63R	IS	1094.--	
					SPSFR63R	DS	1252.--	
					SSFR63RLS	IS		1726.--
					SPSFR63RLS	DS		1884.--



EEK/EEC=Energyeffizienzklasse/energy efficiency category

MOTION »150R«

mit Oberboden inkl. LED Beleuchtungsleisten/*with top incl. LED lighting strip*

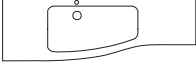
Beschreibung Description	Maße in cm Dimensions in cm			Artikel-Nr. Article no.	Türanschlag	Identnummer ID number
	B/W	H	T/D			

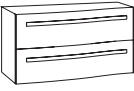
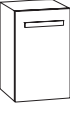
	Mineralmarmor-Waschtisch inkl. Überlauf <i>marble minerals washbasin incl. overflow</i>	150,4	2	48,5/ 35,5	MNWM150R		585.--
--	---	-------	---	---------------	----------	--	---------------

							PG2 matt/matt	PG3 Glanz/gloss
	Waschtisch-Unterschrank 2 Auszüge <i>washbasin base cabinet 2 extensions</i>	90	47,8	48/ 35	MNWUG92DR		819.--	907.--
	Unterschrank 1 Tür, 1 Glaseinlegeboden <i>base cabinet 1 door, 1 glass shelf</i>	30	47,8	35	MNWU30D	L/R	249.--	337.--
		30	47,8	48	MNWU30TD	L/R		
	Unterschrank 2 Auszüge <i>base cabinet 2 extensions</i>	30	47,8	35	MNWUA32D		410.--	497.--
		30	47,8	48	MNWUA32TD			

IS = Spiegeltür mit Trägerplatte 20 mm und aufgeklebtem Innenspiegel (#)/*mirror doors on carrier plate 20 mm with glued inside mirror (#)*

DS = Doppelspiegeltür 6 mm/*double sided mirror doors 6 mm*

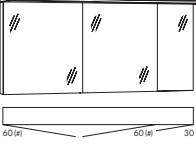
	Spiegelschrank, 3 Spiegeltüren 6 Glaseinlegeböden Oberboden mit LED-Beleuchtung inkl. Schalter/Steckdose EEK A–A++ <i>mirror cabinet, 3 mirror doors 6 glass shelves, top with LED lighting incl. switch/socket EEC A–A++</i>	150	68,2/ 70,7	13,6	SSK663OR	IS	1206.--
				12,2	SPSK663OR	DS	1416.--

A = Regal (korpusfarbig) mit Glasablageböden/*shelf (basic shell coloured) with glass shelves*

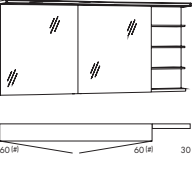
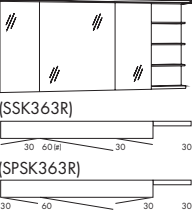
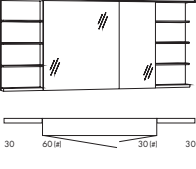

B = Regal mit Spiegel und Glasablageböden (LED)/*shelf with mirror and glass shelves (LED)*

							A	B
	Spiegelschrank, 2 Spiegeltüren 4 Glaseinlegeböden, Regal (!) R, Oberboden mit LED-Beleuchtung inkl. Schalter/Steckdose EEK A–A++ <i>mirror cabinet, 2 mirror doors 4 glass shelves shelf (!) R, top with LED lighting incl. switch/socket EEC A–A++</i>	150	68,2/ 70,7	13,6	SSK66R	IS	1241.--	
				12,2	SPSK66R	DS	1346.--	
				13,6	SSK66RLS	IS	1557.--	
				12,2	SPSK66RLS	DS	1662.--	
	Spiegelschrank, 3 Spiegeltüren 6 (4) Glaseinlegeböden, Regal (!) R, Oberboden mit LED-Beleuchtung inkl. Schalter/Steckdose EEK A–A++ <i>mirror cabinet, 3 mirror doors 6 (4) glass shelves shelf (!) R, top with LED lighting incl. switch/socket EEC A–A++</i>	150	68,2/ 70,7	13,6	SSK363R	IS	1256.--	
				12,2	SPSK363R	DS	1443.--	
				13,6	SSK363RLS	IS	1572.--	
				12,2	SPSK363RLS	DS	1759.--	
	Spiegelschrank, 2 Spiegeltüren 2 Glaseinlegeböden, Regal (!) L+R, Oberboden mit LED-Beleuchtung inkl. Schalter/Steckdose EEK A–A++ <i>mirror cabinet, 2 mirror doors 2 glass shelves shelf (!) L+R, top with LED lighting incl. switch/socket EEC A–A++</i>	150	68,2/ 70,7	13,6	SSKR63R	IS	1276.--	
				12,2	SPSKR63R	DS	1434.--	
				13,6	SSKR63RLS	IS	1908.--	
				12,2	SPSKR63RLS	DS	2066.--	

EEK/EEC=Energieeffizienzklasse/energy efficiency category

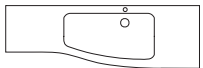
Beschreibung Description	Maße in cm Dimensions in cm			Artikel-Nr. Article no.	Türanschlag	Identnummer ID number
	B/W	H	T/D			

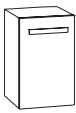
	Mineralmarmor-Waschtisch inkl. Überlauf <i>marble minerals washbasin incl. overflow</i>	150,4	2	35,5/ 48,5	MNWM150L		585.--
---	---	-------	---	---------------	----------	--	---------------

							PG2 matt/matt	PG3 Glanz/gloss
	Waschtisch-Unterschrank 2 Auszüge <i>washbasin base cabinet 2 extensions</i>	90	47,8	48/ 35	MNWUG92DL		819.--	907.--
	Unterschrank 1 Tür, 1 Glaseinlegeboden <i>base cabinet 1 door, 1 glass shelf</i>	30	47,8	35	MNWU30D	L/R	249.--	337.--
		30	47,8	48	MNWU30TD	L/R		
	Unterschrank 2 Auszüge <i>base cabinet 2 extensions</i>	30	47,8	35	MNWUA32D		410.--	497.--
		30	47,8	48	MNWUA32TD			

IS = Spiegeltür mit Trägerplatte 20 mm und aufgeklebtem Innenspiegel (#)/mirror doors on carrier plate 20 mm with glued inside mirror (#)

DS = Doppelspiegeltür 6 mm/double sided mirror doors 6 mm

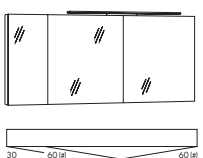
	Spiegelschrank, 3 Spiegeltüren 6 Glaseinlegeböden LED-Aufsatzleuchte 15W inkl. Schalter/Steckdose EEK A-A++ <i>mirror cabinet, 3 mirror doors 6 glass shelves, top light with LED 15W incl. switch/socket EEK A-A++</i>	150	68,2	13,6	SSF366	IS	1024.--
				12,2	SPSF366	DS	1235.--

A = Regal (korpusfarbig) mit Glasablageböden/shelf (basic shell coloured) with glass shelves

B = Regal mit Spiegel und Glasablageböden (LED)/shelf with mirror and glass shelves (LED)

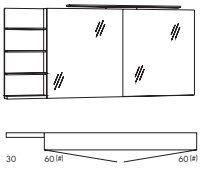
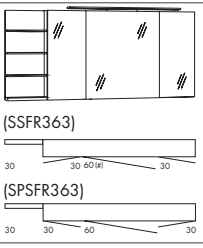
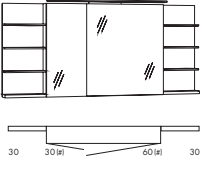
							A	B
	Spiegelschrank, 2 Spiegeltüren 4 Glaseinlegeböden, Regal (!) L, LED-Aufsatzleuchte FL90 15W inkl. Schalter/Steckdose EEK A-A++ <i>mirror cabinet, 2 mirror doors 4 glass shelves, shelf (!) L, top light with LED FL90 15W incl. switch/socket EEK A-A++</i>	150	68,2	13,6	SSFR66	IS	1059.--	
				12,2	SPSFR66	DS	1244.--	
				13,6	SSFR66LS	IS	1375.--	
				12,2	SPSFR66LS	DS	1560.--	
	Spiegelschrank, 3 Spiegeltüren 6 (4) Glaseinlegeböden, Regal (!) L, LED-Aufsatzleuchte FL90 15W inkl. Schalter/Steckdose EEK A-A++ <i>mirror cabinet, 3 mirror doors 6 (4) glass shelves, shelf (!) L, top light with LED FL90 15W incl. switch/socket EEK A-A++</i>	150	68,2	13,6	SSFR363	IS	1074.--	
				12,2	SPSFR363	DS	1261.--	
				13,6	SSFR363LS	IS	1390.--	
				12,2	SPSFR363LS	DS	1577.--	
	Spiegelschrank, 2 Spiegeltüren 2 Glaseinlegeböden, Regal (!) L+R, LED-Aufsatzleuchte FL90 15W inkl. Schalter/Steckdose EEK A-A++ <i>mirror cabinet, 2 mirror doors, 2 glass shelves, shelf (!) L+R, top light with LED FL90 15W incl. switch/socket EEK A-A++</i>	150	68,2	13,6	SSFR36R	IS	1094.--	
				12,2	SPSFR36R	DS	1252.--	
				13,6	SSFR36RLS	IS	1726.--	
				12,2	SPSFR36RLS	DS	1884.--	



EEK/EEC=Energyeffizienzklasse/energy efficiency category

MOTION »150L«

mit Oberboden inkl. LED Beleuchtungsleisten/with top incl. LED lighting strip

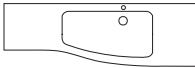
Beschreibung Description	Maße in cm Dimensions in cm			Artikel-Nr. Article no.	Türanschlag	Identnummer ID number
	B/W	H	T/D			

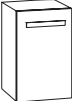
	Mineralmarmor-Waschtisch inkl. Überlauf <i>marble minerals washbasin incl. overflow</i>	150,4	2	48,5/ 35,5	MNWM150L		585.--
--	---	-------	---	---------------	----------	--	---------------

							PG2 matt/matt	PG3 Glanz/gloss
	Waschtisch-Unterschrank 2 Auszüge <i>washbasin base cabinet 2 extensions</i>	90	47,8	48/ 35	MNWUG92DL		819.--	907.--
	Unterschrank 1 Tür, 1 Glaseinlegeboden <i>base cabinet 1 door, 1 glass shelve</i>	30	47,8	35	MNWU30D	L/R	249.--	337.--
		30	47,8	48	MNWU30TD	L/R		
	Unterschrank 2 Auszüge <i>base cabinet 2 extensions</i>	30	47,8	35	MNWUA32D		410.--	497.--
		30	47,8	48	MNWUA32TD			

IS = Spiegeltür mit Trägerplatte 20 mm und aufgeklebtem Innenspiegel (#)/mirror doors on carrier plate 20 mm with glued inside mirror (#)

DS = Doppelspiegeltür 6 mm/double sided mirror doors 6 mm

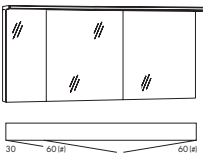



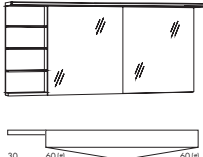
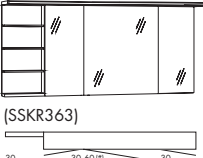
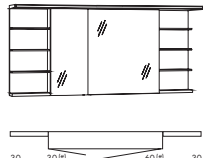

	Spiegelschrank, 3 Spiegeltüren 6 Glaseinlegeböden Oberboden mit LED-Beleuchtung inkl. Schalter/Steckdose EEK A-A++ <i>mirror cabinet, 3 mirror doors 6 glass shelves, top with LED lighting incl. switch/socket EEC A-A++</i>	150	68,2/ 70,7	13,6	SSK366OL	IS	1206.--
				12,2	SPSK366OL	DS	1416.--

A = Regal (korpusfarbig) mit Glasablageböden/shelf (basic shell coloured) with glass shelves

B = Regal mit Spiegel und Glasablageböden (LED)/shelf with mirror and glass shelves (LED)

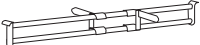

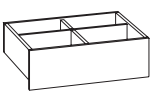





							A	B
	Spiegelschrank, 2 Spiegeltüren 4 Glaseinlegeböden, Regal (!) L, Oberboden mit LED Beleuchtung, inkl. Schalter/Steckdose EEK A-A++ <i>mirror cabinet, 2 mirror doors 4 glass shelves, shelf (!) L, top with LED lighting incl. switch/socket EEC A-A++</i>	150	68,2/ 70,7	13,6	SSKR66	IS	1241.--	
				12,2	SPSKR66	DS	1346.--	
				13,6	SSKR66LS	IS	1557.--	
				12,2	SPSKR66LS	DS	1662.--	
	Spiegelschrank, 3 Spiegeltüren 6 (4) Glaseinlegeböden, Regal (!) L, Oberboden mit LED Beleuchtung, inkl. Schalter/Steckdose EEK A-A++ <i>mirror cabinet, 3 mirror doors 6 (4) glass shelves, shelf (!) L, top with LED lighting incl. switch/socket EEC A-A++</i>	150	68,2/ 70,7	13,6	SSKR363	IS	1256.--	
				12,2	SPSKR363	DS	1443.--	
				13,6	SSKR363LS	IS	1572.--	
				12,2	SPSKR363LS	DS	1759.--	
	Spiegelschrank, 2 Spiegeltüren 2 Glaseinlegeböden, Regal (!) L+R, Oberboden mit LED Beleuchtung, inkl. Schalter/Steckdose EEK A-A++ <i>mirror cabinet, 2 mirror doors, 2 glass shelves, shelf (!) L+R, top with LED lighting incl. switch/socket EEC A-A++</i>	150	68,2/ 70,7	13,6	SSKR36R	IS	1276.--	
				12,2	SPSKR36R	DS	1434.--	
				13,6	SSKR36RLS	IS	1908.--	
				12,2	SPSKR36RLS	DS	2066.--	

EEK/EEC=Energieeffizienzklasse/energy efficiency category

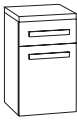

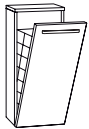
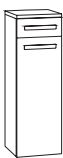



Beschreibung Description	Maße in cm Dimensions in cm			Artikel-Nr. Article no.	Türanschlag	Identnummer ID number
	B/W	H	T/D			
 <p>Handtuchhalter verchromt (Befestigung am Schrank) Montage nur an der tiefen Korpusseite (48 cm)</p> <p><i>chromed towel rail (fastening on the cabinet) Installation only on the deep basic shell side (48 cm)</i></p>	5	2,5	40	MHH		125.--
 <p>Handtuchhalter 2-armig (Befestigung am Schrank) ausziehbar</p> <p><i>towel rail 2-arms (fastening on the cabinet) pull out</i></p>	10,5	4	32,5/ 50	HH233		75.--
 <p>Handtuchhalter 1-armig (Befestigung am Schrank) Montage nur an der tiefen Korpusseite (48 cm)</p> <p><i>towel rail 1-arm (fastening on the cabinet) Installation only on the deep basic shell side (48 cm)</i></p>	5	1	33	HHF133 NEU NEW		23.--
 <p>Inneneinteilung für 90 cm Auszug</p> <p><i>internal subdivision for 90 cm extension</i></p>				IE90D		39.--
 <p>Spiegelschrank-Unterbaubeleuchtung 3W LED EEK A–A++ (für Spiegelschrank ab 80 cm Breite)</p> <p><i>base lighting for mirror cabinet 3W LED EEC A–A++ (for mirror cabinet ex 80 cm width)</i></p>	70			WTB70		141.--
 <p>Spiegelschrank-Unterbaubeleuchtung 4,3W LED EEK A–A++ (für Spiegelschrank ab 120 cm Breite)</p> <p><i>base lighting for mirror cabinet 4,3W LED EEC A–A++ (for mirror cabinet ex 120 cm width)</i></p>	110			WTB110		203.--
 <p>Innenauszug (Holz) für Beistellschränke 40 cm</p> <p><i>internal drawer (wood) for side cabinets 40 cm</i></p>				SKEH40		190.--
 <p>Schubkasteneinsatz (Kunststoff) für Schubkasten 40 cm</p> <p><i>drawer insert part (plastic) for drawer 40 cm</i></p>				SE4		35.--

EEK/EEC=Energieeffizienzklasse/energy efficiency category

MOTION Beistellschränke/*side cabinets*

	Beschreibung <i>Description</i>	Maße in cm <i>Dimensions in cm</i>			Artikel-Nr. <i>Article no.</i>	Türanschlag	Identnummer <i>ID number</i>	
		B/W	H	T/D			PG2 matt/ <i>matt</i>	PG3 Glanz/ <i>gloss</i>
	Oberschrank 1 Tür 2 Glaseinlegeböden <i>top cabinet</i> 1 door 2 glass shelves	40	68,2	13,4	MNOT401D		297.--	391.--
	Unterschrank inkl. Abdeckplatte 1 Tür, 2 Glaseinlegeböden <i>top cabinet</i> 1 door, 2 glass shelves	40	59,9	34,8	MNUT40D_	L/R	210.--	298.--
	Unterschrank inkl. Abdeckplatte 1 Tür, 1 Schubkasten <i>base cabinet incl. top</i> 1 door, 1 drawer	40	50,3	34,8	MNUS40D_	L/R	422.--	579.--
	Highboard inkl. Abdeckplatte 1 Tür 2 Glaseinlegeböden <i>high cabinet incl. top</i> 1 door 2 glass shelves	30 40 40	91,9	34,8 34,8 17,6	MNHB300D_ MNHB400D_ MNHB402D_	L/R L/R L/R	360.--	516.--
	Highboard inkl. Abdeckplatte 1 Tür/Wäschekippe <i>high cabinet incl. top</i> 1 door/linen bin	40	91,9	34,8	MNHBW400D_		422.--	579.--
	Highboard inkl. Abdeckplatte 1 Tür, 1 Schubkasten 2 Glaseinlegeböden <i>high cabinet incl. top</i> 1 door, 1 drawer 2 glass shelves	40	91,9	34,8	MNHB540D_	L/R	516.--	672.--
	Mittelschrank inkl. Abdeckplatte 2 Türen 3 Glaseinlegeböden <i>medium cabinet incl. top</i> 2 doors 3 glass shelves	30 40	149,5	34,8 34,8	MNMIT30D_ MNMIT40D_	L/R L/R	35.--	35.--
	Mittelschrank inkl. Abdeckplatte 1 Tür, 2 Auszüge 2 Glaseinlegeböden <i>medium cabinet incl. top</i> 1 door, 2 extensions 2 glass shelves	40	149,5	34,8	MNMI400D_	L/R	704.--	954.--
	Mittelschrank inkl. Abdeckplatte 2 Türen, 2 Auszüge 2 Glaseinlegeböden <i>medium cabinet incl. top</i> 2 doors, 2 extensions 2 glass shelves	60	149,5	34,8	MNMI600D_		938.--	1189.--

Beschreibung <i>Description</i>	Maße in cm <i>Dimensions in cm</i>			Artikel-Nr. <i>Article no.</i>	Türanschlag	Identnummer <i>ID number</i>	
	B/W	H	T/D			PG2 <i>matt/matt</i>	PG3 <i>Glanz/gloss</i>

	Mittelschrank inkl. Abdeckplatte 4 Türen 3 Glaseinlegeböden <i>medium cabinet incl. top 4 doors 3 glass shelves</i>	60	149,5	34,8	MNMIT600D_ NEU NEW		573.--	698.--
	Hochschrank 2 Türen 4 Glaseinlegeböden <i>tower cabinet 2 doors 4 glass shelves</i>	30	178,7	34,8	MNHT300D	L/R	532.--	782.--
		40	178,7	34,8	MNHT400D	L/R		
		40	178,7	17,6	MNHT402D	L/R		
	Hochschrank 1 Tür / 1 Wäschekippe 2 Glaseinlegeböden <i>tower cabinet 1 door / 1 linen bin 2 glass shelves</i>	40	178,7	34,8	MNHW400D	L/R	594.--	845.--
	Hochschrank 2 Türen, 1 Schubkasten 3 Glaseinlegeböden <i>tower cabinet 2 doors, 1 drawer 3 glass shelves</i>	40	178,7	34,8	MNH407D	L/R	688.--	938.--
	Hochschrank 1 Tür, 3 Auszüge 2 Glaseinlegeböden <i>tower cabinet 1 door, 3 extensions 2 glass shelves</i>	40	178,7	34,8	MNHA400D	L/R	860.--	1110.--
	Hochschrank 2 Türen, 3 Auszüge 2 Glaseinlegeböden <i>tower cabinet 2 doors, 3 extensions 2 glass shelves</i>	60	178,7	34,8	MNHA600D		1158.--	1408.--

 Hochschrank mit Spiegeltür/ *tower cabinet with mirrored door* – MNQ_

	Hochschrank 2 Spiegeltüren 4 Glaseinlegeböden <i>tower cabinet 2 mirrored doors 4 glass shelves</i>	40	178,7	34,8	MNHST400D	L/R	532.--	782.--
		40	178,7	17,6	MNHST402D	L/R		

SPSO9136/SPSO9163 (mit FL90)

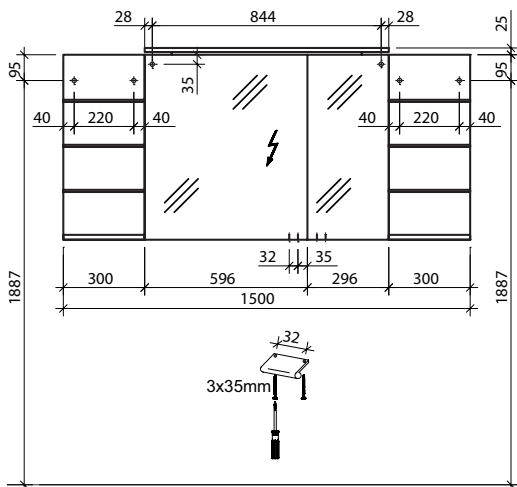

SPSO121363 (mit FL90)

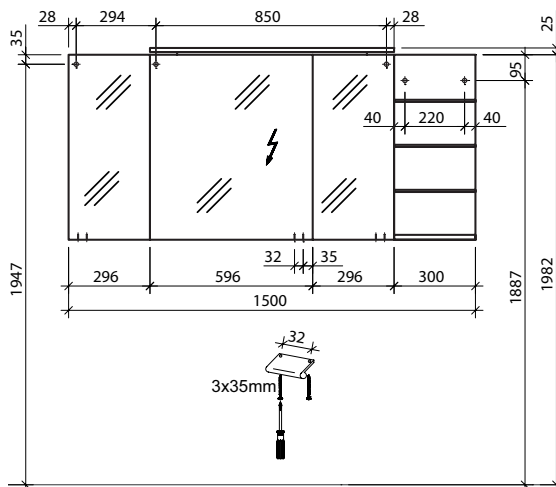

SPSO151663 (mit FL90)

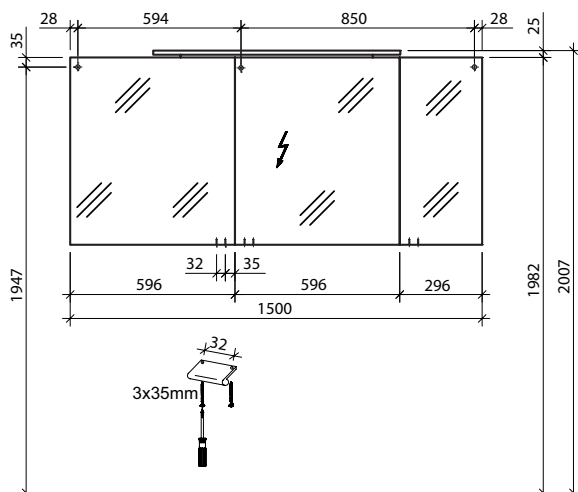

SPSO151366 (mit OB150_)

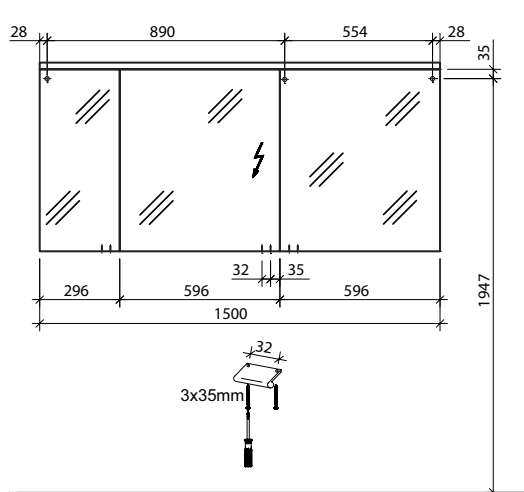

SPSO12166 (mit OB120_)

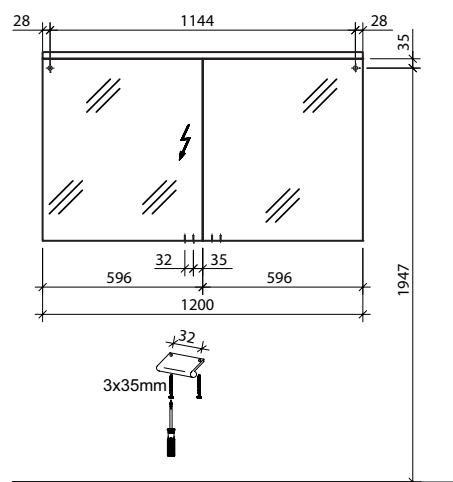

! Achtung: Die Montage muss durch fachkundige Personen erfolgen. Der Untergrund zur Wandbefestigung ist vor Montage zu prüfen. Bitte wählen Sie entsprechend das geeignete Befestigungsmaterial. Fehlerhafte Montagen können das Möbel beschädigen oder dessen Funktion dauerhaft beeinträchtigen. Für Sach- und Personenschäden übernehmen wir im Falle einer unsachgemäßen Montage keine Haftung.

Attention: Assembly must be carried out by skilled personnel. The subsurface for the wall mounting must be checked before assembly. Please select a suitable mounting material. Faulty assembly can damage furniture or permanently impair its function. We will not be held responsible for damage to material or persons in the case of improper assembly.

SPDO9136/SPDO9163 (mit FL90)

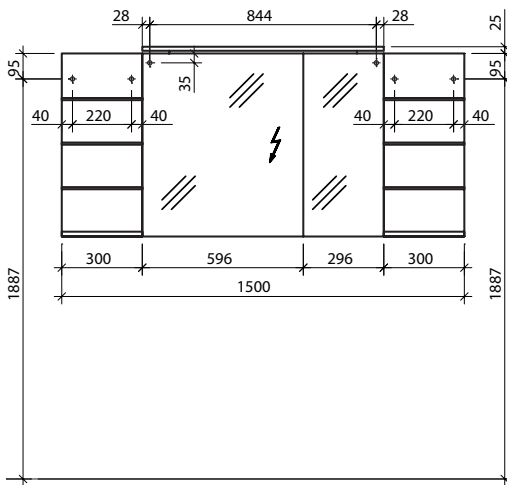

SPDO121363 (mit FL90)

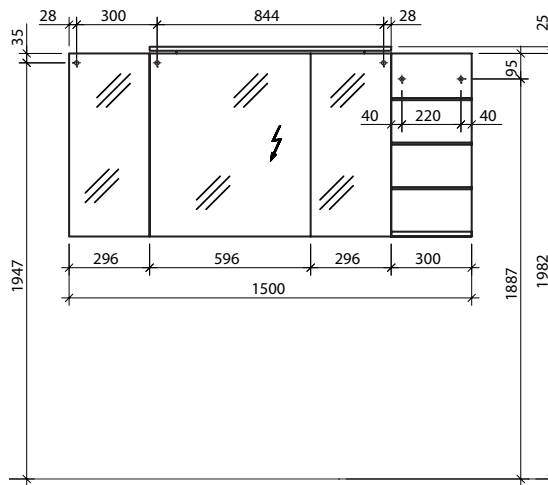

SPDO151663 (mit FL90)

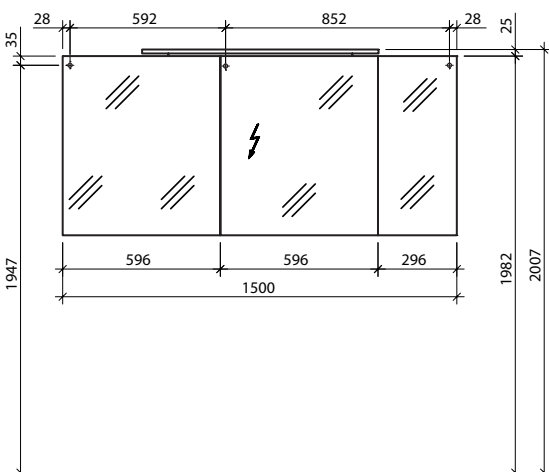

SPDO151366 (mit OB150_)

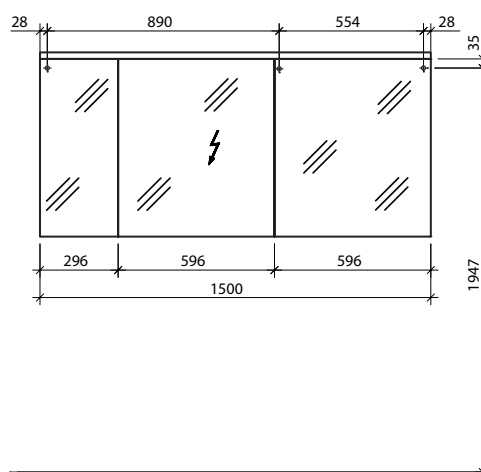

SPDO12166 (mit OB120_)

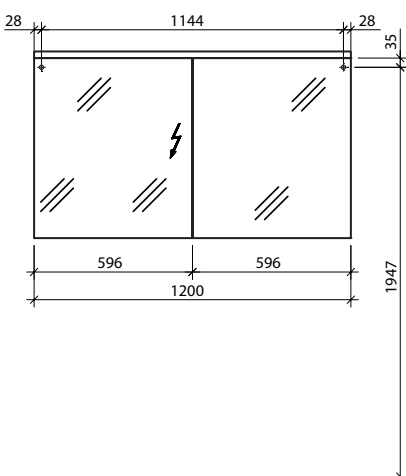

! Achtung: Die Montage muss durch fachkundige Personen erfolgen. Der Untergrund zur Wandbefestigung ist vor Montage zu prüfen. Bitte wählen Sie entsprechend das geeignete Befestigungsmaterial. Fehlerhafte Montagen können das Möbel beschädigen oder dessen Funktion dauerhaft beeinträchtigen. Für Sach- und Personenschäden übernehmen wir im Falle einer unsachgemäßen Montage keine Haftung.
 Attention: Assembly must be carried out by skilled personnel. The subsurface for the wall mounting must be checked before assembly. Please select a suitable mounting material. Faulty assembly can damage furniture or permanently impair its function. We will not be held responsible for damage to material or persons in the case of improper assembly.

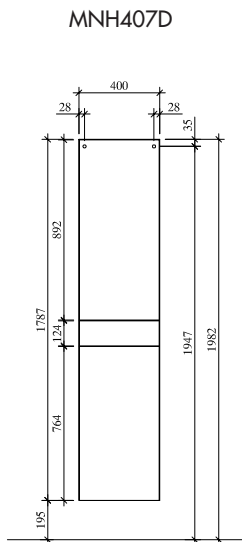
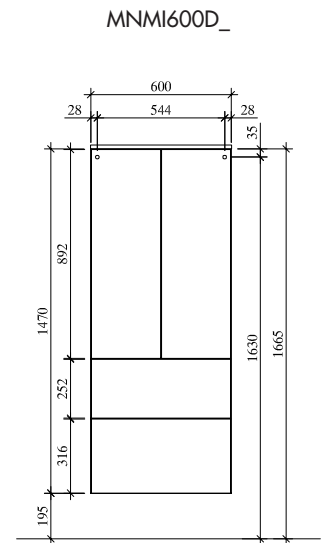
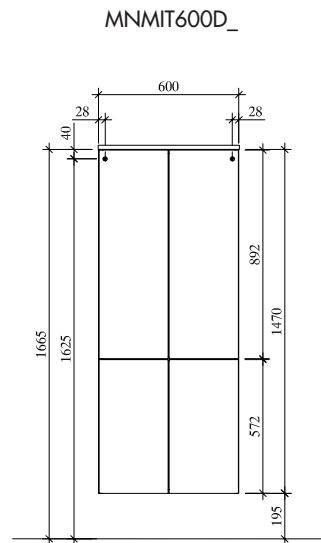
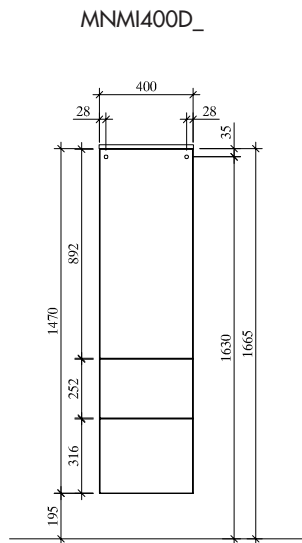
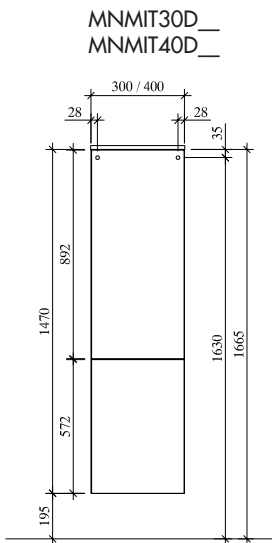

MNHA400D MNHT400D
MNHT300D MNHT402D
MNHV400D

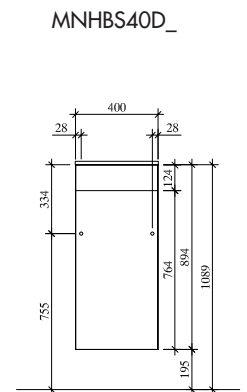
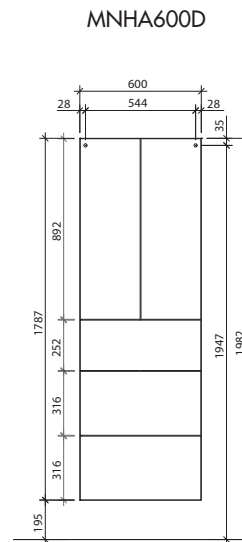
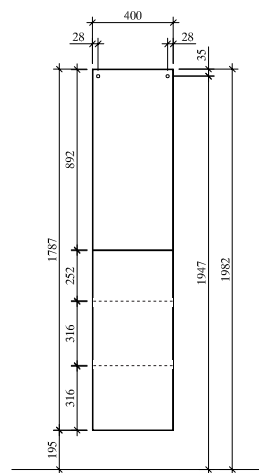

MNHB300D_ MNHB402D_
MNHB400D_ MNHBV400D

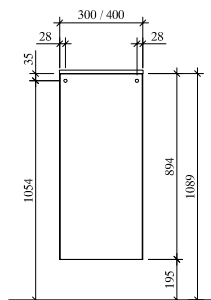

MNUT40D

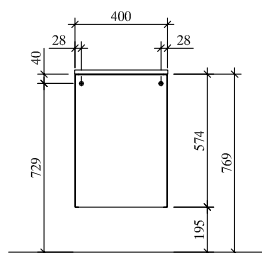

MNUS40D

