

Mineralmarmor Waschtisch weiß alpin Glanz (MY69) *marble minerals washbasin gloss alpine white (MY69)*

»Elegance« (MWTE)

inkl. Clou-Überlaufsystem/*incl. Clou overflow system*

 ≈ Beckenmaße in cm (BxHxT)
basin dimensions in cm (WxHxD)

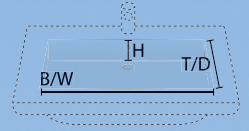

MWTE(L)80 |  __x12x__ cm

MWTE(L)100 |  __x12x__ cm

MWTE(L)130 |  __x12x__ cm



Detailfoto

»Polar« (MWTP)

inkl. Clou-Überlaufsystem/*incl. Clou overflow system*



MWTP(L)80 |  __x12x30 cm

MWTP(L)100 |  __x12x30 cm

MWTP(L)130 |  __x12x30 cm



Detailfoto

(L) mit LED Beleuchtung
with LED lighting

Mineralmarmor Waschtisch weiß alpin Glanz (MY69) marble minerals washbasin gloss alpine white (MY69)

»Loft« (MWLO)

inkl. Clou-Überlaufsystem/*incl. Clou overflow system*

 ≈ Beckenmaße in cm (BxHxT)
basin dimensions in cm (WxHxD)

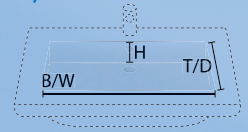

MWLO(L)80 |  60 x 12 x 30 cm



MWLO(L)100 |  60 x 12 x 30 cm



MWLO(L)130 |  55 x 12 x 30 cm



(L) mit LED Beleuchtung
with LED lighting

Griffe/handles

⊕—⊕ = Bohrabstand/*hole spacing*



chrom Glanz
gloss chrome
165/166
⊕—⊕ 160 mm/320 mm



chrom Glanz
gloss chrome
167/168
⊕—⊕ 160 mm/320 mm

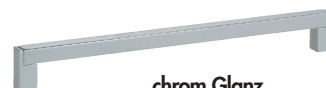

chrom Glanz
gloss chrome
169/171/170
⊕—⊕ 160 mm/320 mm/588 mm



chrom Glanz
gloss chrome
158*/162
⊕—⊕ 192 mm/588 mm



chrom Glanz
gloss chrome
124*/324
⊕—⊕ 160 mm/480 mm



chrom Glanz
gloss chrome
331*/332
⊕—⊕ 160 mm/320 mm

* Griffposition immer horizontal
handle position always horizontally

Schränke/cabinets MYBAD

Frontfarben/front colours

MDF-foliiert/MDF-coated



449
Kastanie graphit Nachbildung
graphite chestnut finish
MKG_



450
Kastanie maron Nachbildung
maroon chestnut finish
MKM_



467
Eiche natur Nachbildung
nature oak
MEN_



463
Kastanie titan Nachbildung
titanium chestnut finish
MKT_



458
Robinie dunkel Nachbildung
robinia dark
MRB_



961
weiß Glanz
gloss white
MWG_



443
Kastanie hell Nachbildung
light chestnut finish
MKA_



438
anthrazit Glanz
gloss anthracite
MAN_

Korpusfarben/basic shell colours

PG 2



449
Kastanie graphit Nachbildung
graphite chestnut finish
C/MY45



450
Kastanie maron Nachbildung
maroon chestnut finish
M/MY85



467
Eiche natur Nachbildung
nature oak
V/MY61



463
Kastanie titan Nachbildung
titanium chestnut finish
I/MY63

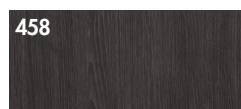

458
Robinie dunkel Nachbildung
robinia dark
J/MY58



130
Kastanie hell Nachbildung
light chestnut finish
K/MY35



PG 3







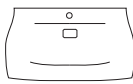
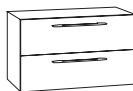

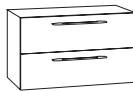
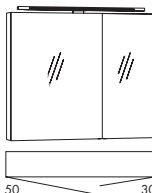
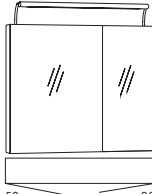
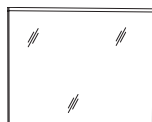
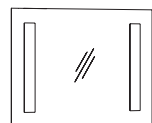
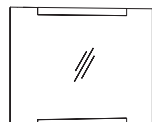
042
weiß Glanz
gloss white
G/MY50

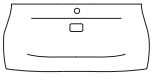

438
anthrazit Glanz
gloss anthracite
F/MY30

Beschreibung Description	Maße in cm Dimensions in cm			Artikel-Nr. Article no.	Türanschlag	Identnummer ID number	
	B/W	H	T/D			ohne Beleuchtung without lighting	mit LED Beleuchtung with LED lighting
 <p>Mineralmarmor-Waschtisch inkl. Clou-Überlaufsystem</p> <p><i>marble minerals washbasin incl. Clou overflow system</i></p>	81,5/ 93,2	4	52,2	MWTE80		767.--	
	83/ 95,9	5,5	52,2	MWTEL80 EEK/EEC: A-A++ LED			913.--
						PG2 matt/matt	PG3 Glanz/gloss
 <p>Waschtisch-Unterschrank 2 Auszüge, nur für MWTE80</p> <p><i>washbasin base cabinet 2 extensions, only for MWTE80</i></p>	80	47,8	48	MWU82D		657.--	813.--
 <p>Waschtisch-Unterschrank 2 Auszüge, nur für MWTEL80 inkl. Schalter im Schrank</p> <p><i>washbasin base cabinet 2 extensions, only for MWTEL80 incl. switch in base cabinet</i></p>	80	47,8	48	MWU82LD		745.--	901.--
 <p>Waschtisch-Unterschrank 2 Auszüge, für MWTE80 und MWTEL80 inkl. Schalter und seitl. LED- Beleuchtung L/R in der Schrankseite</p> <p><i>washbasin base cabinet, 2 extensions, for MWTE80 and MWTEL80 incl. switch and lateral LED lighting L/R at the outside of the base cabinet</i></p>	80	47,8	48	MWU82LED EEK/EEC: A-A++ LED		920.--	1077.--
 <p>Spiegelschrank, 2 vollflächig verspiegelte Türen, 2 Glasein- legeböden, LED Beleuchtung LF70 inkl. Schalter/Steckdose EEK A-A++</p> <p><i>mirror cabinet, 2 full mirrored doors, 2 glass shelves, lighting LED LF70, incl. switch/socket EEC A-A++</i></p>	80	68,2	13,5	SPSLFE801		917.--	
 <p>Spiegelschrank, 2 vollflächig verspiegelte Türen, 2 Glasein- legeböden, Beleuchtung EL70 8,64W inkl. Schalter/Steckdose EEK A-A++</p> <p><i>mirror cabinet, 2 full mirrored doors, 2 glass shelves, lighting EL70 8,64W LED, incl. switch/socket EEC A-A++</i></p>	80	68,2	13,5	SPSEE801		1158.--	
 <p>Spiegelpaneel Oberboden mit 2 LED- Streifen 5, 8 W inkl. Schalter EEK A-A++</p> <p><i>mirror panel top with 2 LED stripes 5,8 W incl. switch EEC A-A++</i></p>	80	68,2/ 70,1	3/ 10	MSPL80		374.--	
 <p>Spiegelpaneel mit vertikalem Lichtaustritt, 2x13W Leuchtstoffröhre EEK A</p> <p><i>mirror panel with vertical source of light, 2x13W fluorescent tube EEC A</i></p>	80	65	5	MSPV80		579.--	
 <p>Spiegelpaneel mit horizontalem Lichtaustritt, 2x14W Leuchtstoffröhre EEK A</p> <p><i>mirror panel with horizontal source of light, 2x14W fluorescent tube EEC A</i></p>	80	68,2	3,5	MSPH80		672.--	

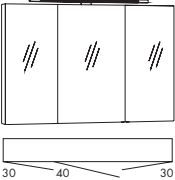
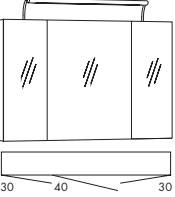
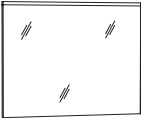
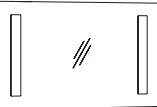

EEK/EEC= Energieeffizienzklasse/energy efficiency category

Beschreibung Description	Maße in cm Dimensions in cm			Artikel-Nr. Article no.	Türanschlag	Identnummer ID number		
	B/W	H	T/D			ohne Beleuchtung without lighting	mit LED Beleuchtung with LED lighting	
 <p>Mineralmarmor-Waschtisch inkl. Clou-Überlaufsystem</p> <p><i>marble minerals washbasin incl. Clou overflow system</i></p>	101/ 113,7	4	52,2	MWTE100		845.--		
	102,6/ 116,1	5,5	52,2	MWTEL100 EEK/EEC: A-A++ LED			991.--	
 <p>Waschtisch-Unterschrank 2 Auszüge, nur für MWTE100</p> <p><i>washbasin base cabinet 2 extensions, only for MWTE100</i></p>	100	47,8	48	MWU102D		719.--	876.--	
	 <p>Waschtisch-Unterschrank 2 Auszüge, nur für MWTEL100 inkl. Schalter im Schrank</p> <p><i>washbasin base cabinet 2 extensions, only for MWTEL100 incl. switch in base cabinet</i></p>	100	47,8	48	MWU102LD		807.--	963.--
		 <p>Waschtisch-Unterschrank, 2 Auszüge, für MWTE100 und MWTEL100 inkl. Schalter und seitl. LED- Beleuchtung L/R in der Schrankseite</p> <p><i>washbasin base cabinet, 2 extensions, for MWTE100 and MWTEL100 incl. switch and lateral LED lighting L/R at the outside of the base cabinet</i></p>	100	47,8	48	MWU102LED EEK/EEC: A-A++ LED		983.--
 <p>Spiegelschrank, 3 vollflächig verspiegelte Türen, 4 Glasein- legeböden, Beleuchtung LED LF70 inkl. Schalter/Steckdose EEK A-A++</p> <p><i>mirror cabinet, 3 full mirrored doors, 4 glass shelves, lighting LED LF70, incl. switch/socket EEC A-A++</i></p>	100	68,2	13,5	SPSLFE101		1105.--		
	 <p>Spiegelschrank, 3 vollflächig verspiegelte Türen, 4 Glasein- legeböden, Beleuchtung EL70 8,64W inkl. Schalter/Steckdose EEK A-A++</p> <p><i>mirror cabinet, 3 full mirrored doors, 4 glass shelves, lighting EL70 8,64W LED, incl. switch/socket EEC A-A++</i></p>	100	68,2	13,5	SPSEE101		1345.--	
 <p>Spiegelpaneel, Oberboden mit 2 LED- Streifen 7,7 W inkl. Schalter EEK A-A++</p> <p><i>mirror panel top with 2 LED stripes 7,7 W incl. switch EEC A-A++</i></p>	100	68,2/ 70,1	3/ 10	MSPL100		422.--		
 <p>Spiegelpaneel mit vertikalem Lichtaustritt, 2x13W Leuchtstoffröhre EEK A</p> <p><i>mirror panel with vertical source of light, 2x13W fluorescent tube EEC A</i></p>	100	65	5	MSPV100		626.--		
 <p>Spiegelpaneel mit horizontalem Lichtaustritt, 2x21W Leuchtstoffröhre EEK A</p> <p><i>mirror panel with horizontal source of light, 2x21W fluorescent tube EEC A</i></p>	100	68,2	3,5	MSPH100		782.--		

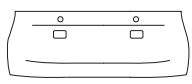

EEK/EEC= Energieeffizienzklasse/energy efficiency category

Beschreibung Description	Maße in cm Dimensions in cm			Artikel-Nr. Article no.	Türanschlag	Identnummer ID number
	B/W	H	T/D			



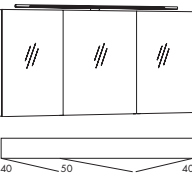
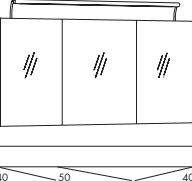

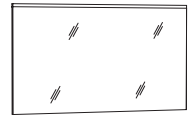
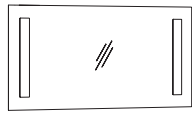

						ohne Beleuchtung without lighting	mit LED Beleuchtung with LED lighting
	Mineralmarmor-Doppel-WT inkl. Clou-Überlaufsystem	131/ 144	4	52,2	MWTED130	1220.--	
	<i>marble minerals double washb. incl. Clou overflow system</i>	132,8/ 146,4	5,5	52,2	MWTEDL130 EEK/EEC: A-A++ LED		1366.--

						PG2 matt/matt	PG3 Glanz/gloss
	Waschtisch-Unterschrank 4 Auszüge, nur für MWTED130	130	47,8	48	MWU132D	1220.--	1470.--
	<i>washbasin base cabinet 4 extensions, only for MWTED130</i>						
	Waschtisch-Unterschrank 4 Auszüge, nur für MWTEDL130 inkl. Schalter im Schrank	130	47,8	48	MWU132LD	1308.--	1558.--
	<i>washbasin base cabinet 4 extensions, only for MWTEDL130 incl. switch in base cabinet</i>						
	Waschtisch-Unterschrank, 4 Auszüge, für MWTED130 und MWTEDL130 inkl. Schalter und seitl. LED- Beleuchtung L/R in der Schrankseite	130	47,8	48	MWU132LED EEK/EEC: A-A++ LED	1483.--	1734.--
	<i>washbasin base cabinet, 4 extensions, for MWTED130 and MWTEDL130 incl. switch and lateral LED lighting L/R at the outside of the base cabinet</i>						

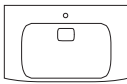



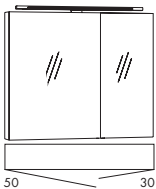
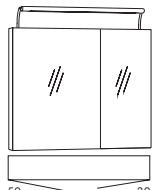

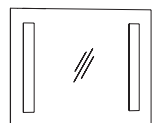
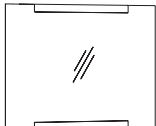
	Spiegelschrank, 3 vollflächig verspiegelte Türen, 4 Glasein- legeböden, Beleuchtung LF110 LED, inkl. Schalter/Steckdose EEK A-A++	130	68,2	13,5	SPSLFE131		1299.--
	<i>mirror cabinet, 3 full mirrored doors, 4 glass shelves, lighting LF110 LED, incl. switch/socket EEC A-A++</i>						
	Spiegelschrank, 3 vollflächig verspiegelte Türen, 4 Glaseinlege- böden, Beleuchtung EL110 14,4W LED, inkl. Schalter/Steckdose EEK A-A++	130	68,2	13,5	SPSEE131		1814.--
	<i>mirror cabinet, 3 full mirrored doors, 4 glass shelves, lighting EL110 14,4W LED, incl. switch/socket EEC A-A++</i>						

	Spiegelpaneel, Oberboden mit 2 LED- Steifen 9,6 W, inkl. Schalter EEK A-A++	120	68,2/ 70,1	3/ 10	MSPL120		467.--
	<i>mirror panel, top with 2 LED stripes 9,6 W, incl. switch EEC A-A++</i>						
	Spiegelpaneel mit vertikalem Lichtaustritt, 2x13W Leuchtstoffröhre EEK A	120	65	5	MSPV120		657.--
	<i>mirror panel with vertical source of light, 2x13W fluorescent tube EEC A</i>						
	Spiegelpaneel mit horizontalem Lichtaustritt, 2x28W Leuchtstoffröhre EEK A	120	68,2	3,5	MSPH120		938.--
	<i>mirror panel with horizontal source of light, 2x28W fluorescent tube EEC A</i>						

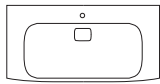

EEK/EEC= Energieeffizienzklasse/energy efficiency category

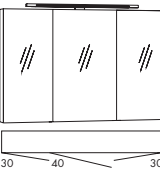
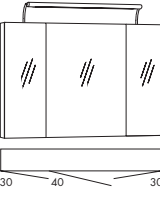
Beschreibung Description	Maße in cm Dimensions in cm			Artikel-Nr. Article no.	Türanschlag	Identnummer ID number	
	B/W	H	T/D			ohne Beleuchtung without lighting	mit LED Beleuchtung with LED lighting
 <p>Mineralmarmor-Waschtisch inkl. Clou-Überlaufsystem <i>marble minerals washbasin incl. Clou overflow system</i></p>	86	5,5	52,5	MWTP80 MWTP80 EEK/EEC: A-A++ LED		767.--	913.--
						PG2 matt/matt	PG3 Glanz/gloss
 <p>Waschtisch-Unterschrank 2 Auszüge, nur für MWTP80 <i>washbasin base cabinet 2 extensions, only for MWTP80</i></p>	80	47,8	48	MWU82D		657.--	813.--
 <p>Waschtisch-Unterschrank 2 Auszüge, nur für MWTP80 inkl. Schalter im Schrank <i>washbasin base cabinet 2 extensions, only for MWTP80 incl. switch in base cabinet</i></p>	80	47,8	48	MWU82LD		745.--	901.--
 <p>Waschtisch-Unterschrank, 2 Auszüge, für MWTP80 und MWTP80 inkl. Schalter und seitl. LED- Beleuchtung L/R in der Schrankseite <i>washbasin base cabinet, 2 extensions, for MWTP80 and MWTP80 incl. switch and lateral LED lighting L/R at the outside of the base cabinet</i></p>	80	47,8	48	MWU82LED EEK/EEC: A-A++ LED		920.--	1077.--
 <p>Spiegelschrank, 2 vollflächig verspiegelte Türen, 2 Glasein- legeböden, LED Beleuchtung LF70 inkl. Schalter/Steckdose EEK A-A++ <i>mirror cabinet, 2 full mirrored doors, 2 glass shelves, lighting LED LF70, incl. switch/socket EEC A-A++</i></p>	80	68,2	13,5	SPSLFE801			917.--
 <p>Spiegelschrank, 2 vollflächig verspiegelte Türen, 2 Glasein- legeböden, Beleuchtung EL70 8,64W inkl. Schalter/Steckdose EEK A-A++ <i>mirror cabinet, 2 full mirrored doors, 2 glass shelves, lighting EL70 8,64W LED, incl. switch/socket EEC A-A++</i></p>	80	68,2	13,5	SPSEE801			1158.--
 <p>Spiegelpaneel, Oberboden mit 2 LED- Streifen 5,8 W inkl. Schalter EEK A-A++ <i>mirror panel, top with 2 LED stripes 5,8 W incl. switch EEC A-A++</i></p>	80	68,2/ 70,1	3/ 10	MSPL80			374.--
 <p>Spiegelpaneel mit vertikalem Lichtaustritt, 2x13W Leuchtstoffröhre EEK A <i>mirror panel with vertical source of light, 2x13W fluorescent tube EEC A</i></p>	80	65	5	MSPV80			579.--
 <p>Spiegelpaneel mit horizontalem Lichtaustritt, 2x14W Leuchtstoffröhre EEK A <i>mirror panel with horizontal source of light, 2x14W fluorescent tube EEC A</i></p>	80	68,2	3,5	MSPH80			672.--

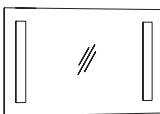
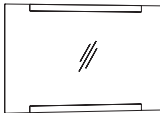

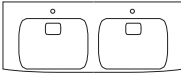
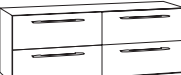

EEK/EEC= Energieeffizienzklasse/energy efficiency category

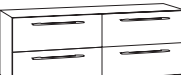
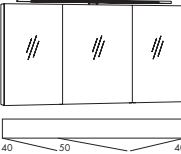
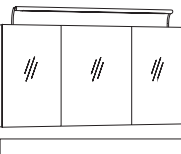
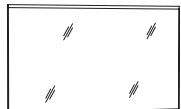
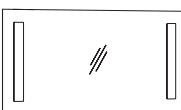
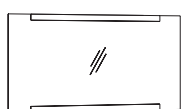
Beschreibung Description	Maße in cm Dimensions in cm			Artikel-Nr. Article no.	Türanschlag	Identnummer ID number	
	B/W	H	T/D			ohne Beleuchtung without lighting	mit LED Beleuchtung with LED lighting
 <p>Mineralmarmor-Waschtisch inkl. Clou-Überlaufsystem <i>marble minerals washbasin incl. Clou overflow system</i></p>	106	5,5	53	MWTP100 MWTPL100 EEK/EEC: A-A++ LED		845.--	991.--
						PG2 matt/matt	PG3 Glanz/gloss
 <p>Waschtisch-Unterschrank 2 Auszüge, nur für MWTP100 <i>washbasin base cabinet 2 extensions, only for MWTP100</i></p>	100	47,8	48	MWU102D		719.--	876.--
 <p>Waschtisch-Unterschrank 2 Auszüge, nur für MWTPL100 inkl. Schalter im Schrank <i>washbasin base cabinet 2 extensions, only for MWTPL100 incl. switch in base cabinet</i></p>	100	47,8	48	MWU102LD		807.--	963.--
 <p>Waschtisch-Unterschrank, 2 Auszüge, für MWTP100 und MWTPL100 inkl. Schalter und seitl. LED- Beleuchtung L/R in der Schrankseite <i>washbasin base cabinet, 2 extensions, for MWTP100 and MWTPL100 incl. switch and lateral LED lighting L/R at the outside of the base cabinet</i></p>	100	47,8	48	MWU102LED EEK/EEC: A-A++ LED		983.--	1139.--
 <p>Spiegelschrank, 3 vollflächig verspiegelte Türen, 4 Glasein- legeböden, Beleuchtung LED LF70 inkl. Schalter/Steckdose EEK A-A++ <i>mirror cabinet, 3 full mirrored doors, 4 glass shelves, lighting LED LF70, incl. switch/socket EEC A-A++</i></p>	100	68,2	13,5	SPSLFE101		1105.--	
 <p>Spiegelschrank, 3 vollflächig verspiegelte Türen, 4 Glasein- legeböden, Beleuchtung EL70 8,64W inkl. Schalter/Steckdose EEK A-A++ <i>mirror cabinet, 3 full mirrored doors, 4 glass shelves, lighting EL70 8,64W LED, incl. switch/socket EEC A-A++</i></p>	100	68,2	13,5	SPSEE101		1345.--	
 <p>Spiegelpaneel, Oberboden mit 2 LED- Streifen 7,7 W inkl. Schalter EEK A-A++ <i>mirror panel top with 2 LED stripes 7,7 W incl. switch EEC A-A++</i></p>	100	68,2/ 70,1	3/ 10	MSPL100		422.--	
 <p>Spiegelpaneel mit vertikalem Lichtaustritt, 2x13W Leuchtstoffröhre EEK A <i>mirror panel with vertical source of light, 2x13W fluorescent tube EEC A</i></p>	100	65	5	MSPV100		626.--	
 <p>Spiegelpaneel mit horizontalem Lichtaustritt, 2x21W Leuchtstoffröhre EEK A <i>mirror panel with horizontal source of light, 2x21W fluorescent tube EEC A</i></p>	100	68,2	3,5	MSPH100		782.--	



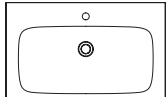

EEK/EEC= Energieeffizienzklasse/energy efficiency category

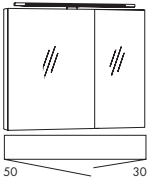
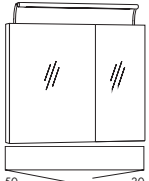
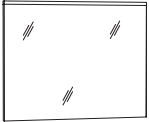
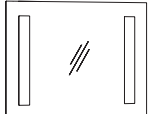
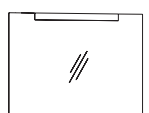
Beschreibung Description	Maße in cm Dimensions in cm			Artikel-Nr. Article no.	Türanschlag	Identnummer ID number	
	B/W	H	T/D			ohne Beleuchtung without lighting	mit LED Beleuchtung with LED lighting
 <p>Mineralmarmor-Doppel-WT inkl. Clou-Überlaufsystem <i>marble minerals double washb. incl. Clou overflow system</i></p>	136	5,5	53,5	MWTP130 MWTP130 EEK/EEC: A-A++ LED		1220.-- 1366.--	
						PG2 matt/matt	PG3 Glanz/gloss
 <p>Waschtisch-Unterschrank 4 Auszüge, nur für MWTP130 <i>washbasin base cabinet 4 extensions, only for MWTP130</i></p>	130	47,8	48	MWU132D		1220.-- 1470.--	
 <p>Waschtisch-Unterschrank 4 Auszüge, nur für MWTP130 inkl. Schalter im Schrank <i>washbasin base cabinet 4 extensions, only for MWTP130 incl. switch in base cabinet</i></p>	130	47,8	48	MWU132LD		1308.-- 1558.--	
 <p>Waschtisch-Unterschrank, 4 Auszüge, für MWTP130 und MWTP130 inkl. Schalter und seitl. LED- Beleuchtung L/R in der Schrankseite <i>washbasin base cabinet, 4 extensions, for MWTP130 and MWTP130 incl. switch and lateral LED lighting L/R at the outside of the base cabinet</i></p>	130	47,8	48	MWU132LED EEK/EEC: A-A++ LED	1483.-- 1734.--		
 <p>Spiegelschrank, 3 vollflächig verspiegelte Türen, 4 Glasein- legeböden, Beleuchtung LF110 LED, inkl. Schalter/Steckdose EEK A-A++ <i>mirror cabinet, 3 full mirrored doors, 4 glass shelves, lighting LF110 LED, incl. switch/socket EEC A-A++</i></p>	130	68,2	13,5	SPSLFE131		1299.--	
 <p>Spiegelschrank, 3 vollflächig verspiegelte Türen, 4 Glaseinlege- böden, Beleuchtung EL110 14,4W LED, inkl. Schalter/Steckdose EEK A-A++ <i>mirror cabinet, 3 full mirrored doors, 4 glass shelves, lighting EL110 14,4W LED, incl. switch/socket EEC A-A++</i></p>	130	68,2	13,5	SPSEE131		1814.--	
 <p>Spiegelpaneel, Oberboden mit 2 LED- Steifen 9,6 W, inkl. Schalter EEK A-A++ <i>mirror panel, top with 2 LED stripes 9,6 W, incl. switch EEC A-A++</i></p>	120	68,2/ 70,1	3/ 10	MSPL120		467.--	
 <p>Spiegelpaneel mit vertikalem Lichtaustritt, 2x13W Leuchtstoffröhre EEK A <i>mirror panel with vertical source of light, 2x13W fluorescent tube EEC A</i></p>	120	65	5	MSPV120		657.--	
 <p>Spiegelpaneel mit horizontalem Lichtaustritt, 2x28W Leuchtstoffröhre EEK A <i>mirror panel with horizontal source of light, 2x28W fluorescent tube EEC A</i></p>	120	68,2	3,5	MSPH120		938.--	



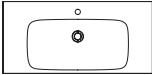

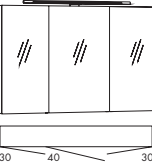
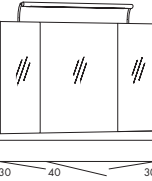
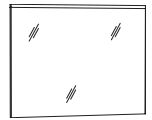
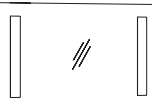
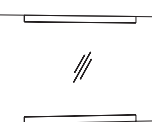

EEK/EEC= Energieeffizienzklasse/energy efficiency category

Beschreibung Description	Maße in cm Dimensions in cm			Artikel-Nr. Article no.	Türanschlag	Identnummer ID number	
	B/W	H	T/D			ohne Beleuchtung without lighting	mit LED Beleuchtung with LED lighting
 <p>Mineralmarmor-Waschtisch inkl. Clou-Überlaufsystem <i>marble minerals washbasin incl. Clou overflow system</i></p>	80,5	1,5	48,5	MWLO80		498.--	
				MWLO180 EEK/EEC: A-A++ LED			725.--
						PG2 matt/matt	PG3 Glanz/gloss
 <p>Waschtisch-Unterschrank 2 Auszüge, nur für MWLO80 <i>washbasin base cabinet 2 extensions, only for MWLO80</i></p>	80	47,8	48	MWU82D		657.--	813.--
 <p>Waschtisch-Unterschrank 2 Auszüge, nur für MWLO180 inkl. Schalter im Schrank <i>washbasin base cabinet 2 extensions, only for MWLO180 incl. switch in base cabinet</i></p>	80	47,8	48	MWU82LD		745.--	901.--
 <p>Waschtisch-Unterschrank, 2 Auszüge, für MWLO80 und MWLO180 inkl. Schalter und seitl. LED- Beleuchtung L/R in der Schrankseite <i>washbasin base cabinet, 2 extensions, for MWLO80 and MWLO180 incl. switch and lateral LED lighting L/R at the outside of the base cabinet</i></p>	80	47,8	48	MWU82LED EEK/EEC: A-A++ LED		920.--	1077.--
 <p>Spiegelschrank, 2 vollflächig verspiegelte Türen, 2 Glasein- legeböden, LED Beleuchtung LF70 inkl. Schalter/Steckdose EEK A-A++ <i>mirror cabinet, 2 full mirrored doors, 2 glass shelves, lighting LED LF70, incl. switch/socket EEC A-A++</i></p>	80	68,2	13,5	SPSLFE801		917.--	
 <p>Spiegelschrank, 2 vollflächig verspiegelte Türen, 2 Glasein- legeböden, Beleuchtung EL70 8,64W inkl. Schalter/Steckdose EEK A-A++ <i>mirror cabinet, 2 full mirrored doors, 2 glass shelves, lighting EL70 8,64W LED, incl. switch/socket EEC A-A++</i></p>	80	68,2	13,5	SPSEE801		1158.--	
 <p>Spiegelpaneel, Oberboden mit 2 LED- Streifen 5,8 W inkl. Schalter EEK A-A++ <i>mirror panel, top with 2 LED stripes 5,8 W incl. switch EEC A-A++</i></p>	80	68,2/ 70,1	3/ 10	MSPL80		374.--	
 <p>Spiegelpaneel mit vertikalem Lichtaustritt, 2x13W Leuchtstoffröhre EEK A <i>mirror panel with vertical source of light, 2x13W fluorescent tube EEC A</i></p>	80	65	5	MSPV80		579.--	
 <p>Spiegelpaneel mit horizontalem Lichtaustritt, 2x14W Leuchtstoffröhre EEK A <i>mirror panel with horizontal source of light, 2x14W fluorescent tube EEC A</i></p>	80	68,2	3,5	MSPH80		672.--	





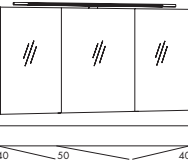
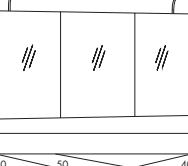
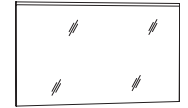



EEK/EEC= Energieeffizienzklasse/energy efficiency category





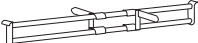

Beschreibung Description	Maße in cm Dimensions in cm			Artikel-Nr. Article no.	Türanschlag	Identnummer ID number	
	B/W	H	T/D			ohne Beleuchtung without lighting	mit LED Beleuchtung with LED lighting
 <p>Mineralmarmor-Waschtisch inkl. Clou-Überlaufsystem</p> <p><i>marble minerals washbasin incl. Clou overflow system</i></p>	100,5	1,5	48,5	MWLO100		561.--	
				MWLOL100 EEK/EEC: A-A++ LED			787.--
 <p>Waschtisch-Unterschrank 2 Auszüge, nur für MWLO100</p> <p><i>washbasin base cabinet 2 extensions, only for MWLO100</i></p>	100	47,8	48	MWU102D		PG2 matt/matt 719.--	PG3 Glanz/gloss 876.--
				 <p>Waschtisch-Unterschrank 2 Auszüge, nur für MWLOL100 inkl. Schalter im Schrank</p> <p><i>washbasin base cabinet 2 extensions, only for MWLOL100 incl. switch in base cabinet</i></p>	MWU102LD	807.--	963.--
					 <p>Waschtisch-Unterschrank, 2 Auszüge, für MWLO100 und MWLOL100 inkl. Schalter und seitl. LED- Beleuchtung L/R in der Schrankseite</p> <p><i>washbasin base cabinet, 2 extensions, for MWLO100 and MWLOL100 incl. switch and lateral LED lighting L/R at the outside of the base cabinet</i></p>	MWU102LED EEK/EEC: A-A++ LED	983.--
 <p>Spiegelschrank, 3 vollflächig verspiegelte Türen, 4 Glasein- legeböden, Beleuchtung LED LF70 inkl. Schalter/Steckdose EEK A-A++</p> <p><i>mirror cabinet, 3 full mirrored doors, 4 glass shelves, lighting LED LF70, incl. switch/socket EEC A-A++</i></p>	100	68,2	13,5	SPLFE101		1105.--	
				 <p>Spiegelschrank, 3 vollflächig verspiegelte Türen, 4 Glasein- legeböden, Beleuchtung EL70 8,64W inkl. Schalter/Steckdose EEK A-A++</p> <p><i>mirror cabinet, 3 full mirrored doors, 4 glass shelves, lighting EL70 8,64W LED, incl. switch/socket EEC A-A++</i></p>	SPSEE101		1345.--
 <p>Spiegelpaneel, Oberboden mit 2 LED- Streifen 7,7 W inkl. Schalter EEK A-A++</p> <p><i>mirror panel top with 2 LED stripes 7,7 W incl. switch EEC A-A++</i></p>	100	68,2/ 70,1	3/ 10	MSPL100		422.--	
 <p>Spiegelpaneel mit vertikalem Lichtaustritt, 2x13W Leuchtstoffröhre EEK A</p> <p><i>mirror panel with vertical source of light, 2x13W fluorescent tube EEC A</i></p>	100	65	5	MSPV100		626.--	
 <p>Spiegelpaneel mit horizontalem Lichtaustritt, 2x21W Leuchtstoffröhre EEK A</p> <p><i>mirror panel with horizontal source of light, 2x21W fluorescent tube EEC A</i></p>	100	68,2	3,5	MSPH100		782.--	

EEK/EEC= Energieeffizienzklasse/energy efficiency category

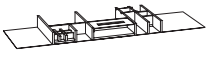





Beschreibung Description	Maße in cm Dimensions in cm			Artikel-Nr. Article no.	Türanschlag	Identnummer ID number	
	B/W	H	T/D			ohne Beleuchtung without lighting	mit LED Beleuchtung with LED lighting
 <p>Mineralmarmor-Doppel-WT inkl. Clou-Überlaufsystem <i>marble minerals double washb. incl. Clou overflow system</i></p>	130,5	1,5	48,5	MWLO130		767.--	
				MWLOL130 EEK/EEC: A-A++ LED			994.--
 <p>Waschtisch-Unterschrank 4 Auszüge, nur für MWLO130 <i>washbasin base cabinet 4 extensions, only for MWLO130</i></p>	130	47,8	48	MWU132D		PG2 matt/matt 1220.--	PG3 Glanz/gloss 1470.--
				 <p>Waschtisch-Unterschrank 4 Auszüge, nur für MWLOL130 inkl. Schalter im Schrank <i>washbasin base cabinet 4 extensions, only for MWLOL130 incl. switch in base cabinet</i></p>	MWU132LD	1308.--	1558.--
					 <p>Waschtisch-Unterschrank, 4 Auszüge, für MWLO130 und MWLOL130 inkl. Schalter und seitl. LED- Beleuchtung L/R in der Schrankseite <i>washbasin base cabinet, 4 extensions, for MWLO100 and MWLOL100 incl. switch and lateral LED lighting L/R at the outside of the base cabinet</i></p>	MWU132LED EEK/EEC: A-A++ LED	1483.--
 <p>Spiegelschrank, 3 vollflächig verspiegelte Türen, 4 Glasein- legeböden, Beleuchtung LF110 LED, inkl. Schalter/Steckdose EEK A-A++ <i>mirror cabinet, 3 full mirrored doors, 4 glass shelves, lighting LF110 LED, incl. switch/socket EEC A-A++</i></p>	130	68,2	13,5	SPSLFE131		1299.--	
				 <p>Spiegelschrank, 3 vollflächig verspiegelte Türen, 4 Glaseinlege- böden, Beleuchtung EL110 14,4W LED, inkl. Schalter/Steckdose EEK A-A++ <i>mirror cabinet, 3 full mirrored doors, 4 glass shelves, lighting EL110 14,4W LED, incl. switch/socket EEC A-A++</i></p>	SPSEE131		1814.--
 <p>Spiegelpaneel, Oberboden mit 2 LED- Steifen 9,6 W, inkl. Schalter EEK A-A++ <i>mirror panel, top with 2 LED stripes 9,6 W, incl. switch EEC A-A++</i></p>	120	68,2/ 70,1	3/ 10	MSPL120		467.--	
 <p>Spiegelpaneel mit vertikalem Lichtaustritt, 2x13W Leuchtstoffröhre EEK A <i>mirror panel with vertical source of light, 2x13W fluorescent tube EEC A</i></p>	120	65	5	MSPV120		657.--	
 <p>Spiegelpaneel mit horizontalem Lichtaustritt, 2x28W Leuchtstoffröhre EEK A <i>mirror panel with horizontal source of light, 2x28W fluorescent tube EEC A</i></p>	120	68,2	3,5	MSPH120		938.--	

EEK/EEC= Energieeffizienzklasse/energy efficiency category

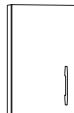
Beschreibung Description	Maße in cm Dimensions in cm			Artikel-Nr. Article no.	Türanschlag	Identnummer ID number
	B/W	H	T/D			
 <p>Handtuchhalter verchromt (Befestigung am Schrank) <i>chromed towel rail (fastening on the cabinet)</i></p>	5	2,5	40	MHH		125.--
 <p>Handtuchhalter 2-armig (Befestigung am Schrank) ausziehbar <i>towel rail 2-arms (fastening on the cabinet) pull out</i></p>	10,5	4	32,5/ 50	HH233		75.--
 <p>Handtuchhalter 1-armig (Befestigung am Schrank) <i>towel rail 1-arm (fastening on the cabinet)</i></p>	5	1	33	HHF133 NEU NEW		33.--
 <p>Inneneinteilung für 65 cm Auszug <i>internal subdivison for 65 cm extension</i></p>				IE65D		39.--
 <p>Inneneinteilung für 80 cm Auszug <i>internal subdivison for 80 cm extension</i></p>				IE80D		39.--
 <p>Inneneinteilung für 100 cm Auszug <i>internal subdivison for 100 cm extension</i></p>				IE100D		39.--
 <p>Schubkasteneinsatz (Kunststoff) für Schubkasten 40 cm <i>drawer insert part (plastic) for drawer 40 cm</i></p>				SE4		35.--
 <p>für/for MWU82D/LD/LED Schubkasteneinsatz (Kunststoff) für oberen Auszug vom WT-Unterschrank <i>drawer insert part (plastic) for top drawer from base cabinet</i></p>	72,2	6,3	32,6	SKEW80		129.--
 <p>für/for MWU102D/LD/LED Schubkasteneinsatz (Kunststoff) für oberen Auszug vom WT-Unterschrank <i>drawer insert part (plastic) for top drawer from base cabinet</i></p>	92,2	6,3	32,6	SKEW100		146.--
 <p>Innenauszug (Holz) für Beistellschränke 40 cm <i>internal drawer (wood) for side cabinets 40 cm</i></p>				SKEH40		190.--

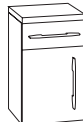
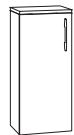
Beschreibung Description	Maße in cm Dimensions in cm			Artikel-Nr. Article no.	Türanschlag	Identnummer ID number
	B/W	H	T/D			
 <p>für/for MWU82D/LD/LED Inneneinteilung (Holz) für oberen Auszug vom WT-Unterschrank (Anti-Rutschmatte, div. Einteilungen, Metalldeckel für Tuchbox)</p> <p><i>internal subdivision (wood) for top drawer from base cabinet (anti slide mat, different subdivision, metal lid f. cleansing tissue box)</i></p>				SKEH80		290.--
 <p>für/for MWU102D/LD/LED Inneneinteilung (Holz) für oberen Auszug vom WT-Unterschrank (Anti-Rutschmatte, div. Einteilungen, Metalldeckel für Tuchbox)</p> <p><i>internal subdivision (wood) for top drawer from base cabinet (anti slide mat, dif. subdivision, metal lid f. cleansing tissue box)</i></p>				SKEH100		290.--
 <p>Spiegelschrank-Unterbaubeleuchtung 3W LED EEK A-A++ (für Spiegelschrank ab 80 cm Breite)</p> <p><i>base lighting for mirror cabinet 3W LED EEC A-A++ (for mirror cabinet ex 80 cm width)</i></p>	70			WTB70		141.--
 <p>Spiegelschrank-Unterbaubeleuchtung 4,3W LED EEK A-A++ (für Spiegelschrank ab 120 cm Breite)</p> <p><i>base lighting for mirror cabinet 4,3W LED EEC A-A++ (for mirror cabinet ex 120 cm width)</i></p>	110			WTB110		203.--
 <p>Steckboden in Korpusfarbe (Unterseite weiß) inkl. 2 verchromten Wandhaltern</p> <p><i>plug-in shelv in basic colour (white bottom) incl. 2 chromed wall attachments</i></p>	80	1,6	12	SB80		125.--
 <p>Steckboden in Korpusfarbe (Unterseite weiß) inkl. 2 verchromten Wandhaltern</p> <p><i>plug-in shelv in basic colour (white bottom) incl. 2 chromed wall attachments</i></p>	100	1,6	12	SB100		141.--
 <p>Steckboden in Korpusfarbe (Unterseite weiß) inkl. 2 verchromten Wandhaltern</p> <p><i>plug-in shelv in basic colour (white bottom) incl. 2 chromed wall attachments</i></p>	120	1,6	12	SB120		156.--
<p>Spiegelheizung für Spiegelpaneel MSPV... und MSPH...</p> <p><i>mirror heater for mirror panel MSPV... and MSPH...</i></p>	50	30		SH		266.--

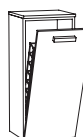

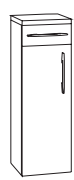





EEK/EEC= Energieeffizienzklasse/energy efficiency category

	Beschreibung <i>Description</i>	Maße in cm <i>Dimensions in cm</i>			Artikel-Nr. <i>Article no.</i>	Türanschlag	Identnummer <i>ID number</i>	
		B/W	H	T/D			PG2 matt/matt	PG3 Glanz/gloss
	Oberschrank 1 Tür, 2 Glaseinlegeböden <i>top cabinet 1 door, 2 glass shelves</i>	40	68,2	13,4	MO401D	L/R	266.--	360.--
	Unterschrank inkl. Abdeckplatte 1 Tür, 2 Glaseinlegeböden <i>top cabinet 1 door, 2 glass shelves</i>	40	59,9	34,8	UT40D_	L/R	330.--	468.--
	Unterschrank inkl. Abdeckplatte 1 Tür, 1 Schubkasten <i>base cabinet incl. top 1 door, 1 drawer</i>	40	50,3	34,8	US40D_	L/R	422.--	579.--
	Highboard inkl. Abdeckplatte 1 Tür, 2 Glaseinlegeböden <i>high cabinet incl. top 1 door, 2 glass shelves</i>	30	91,9	34,8	MHB300D_	L/R	360.--	516.--
		40	91,9	17,6	MHB402D_	L/R		
		40	91,9	34,8	MHB400D_	L/R		
	! Highboard inkl. Abdeckplatte 1 Tür, 2 Glaseinlegeböden inkl. seitlich eingeb. LED-Beleucht. EEK A-A++ <i>high cabinet incl. top 1 door, 2 glass shelves incl. LED lighting built-in sideways EEC A-A++</i>	30	91,9	34,8	MHB30LD_	L/R	550.--	706.--
		40	91,9	34,8	MHB40LD_	L/R		
	Highboard inkl. Abdeckplatte 1 Tür/Wäschekippe <i>high cabinet incl. top 1 door/linen bin</i>	40	91,9	34,8	MHBW400D_		422.--	579.--
	! Highboard inkl. Abdeckplatte 1 Tür/Wäschekippe inkl. seitlich eingeb. LED-Beleucht. EEK A-A++ <i>high cabinet incl. top 1 door/linen bin incl. LED lighting built-in sideways EEC A-A++</i>	40	91,9	34,8	MHBW40LD_	L/R	612.--	769.--
	Highboard inkl. Abdeckplatte 1 Tür, 1 Schubkasten 2 Glaseinlegeböden <i>high cabinet incl. top 1 door, 1 drawer 2 glass shelves</i>	40	91,9	34,8	MHBS400D_	L/R	516.--	672.--
	! Highboard inkl. Abdeckplatte 1 Tür, 1 Schubkasten, 2 Glaseinlegeb. inkl. seitlich eingeb. LED-Beleucht. EEK A-A++ <i>high cabinet incl. top 1 door, 1 drawer, 2 glass shelves incl. LED lighting built-in sideways EEC A-A++</i>	40	91,9	34,8	MHBS40LD_	L/R	706.--	863.--

! Bitte beachten: Die seitliche LED-Beleuchtung ist immer in der Schrankseite gegenüber des Türanschlages montiert. Beim Highboard mit Wäschekippe muss die gewünschte Seite angegeben werden. / *Please note: The lateral LED lighting is always mounted to the side across the door hinge. For the highboard with linen bin it has to be specified.*

EEK/EEC= Energieeffizienzklasse/energy efficiency category

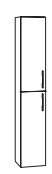





MYBAD Beistellschränke/ *side cabinets*

Beschreibung <i>Description</i>	Maße in cm <i>Dimensions in cm</i>			Artikel-Nr. <i>Article no.</i>	Türanschlag	Identnummer <i>ID number</i>		
	B/W	H	T/D			PG2 matt/matt	PG3 Glanz/gloss	
	Mittelschrank inkl. Abdeckplatte 2 Türen, 3 Glaseinlegeböden	30	149,5	34,8	MMIT300D_	L/R	451.--	620.--
	<i>medium cabinet incl. top 2 doors, 3 glass shelves</i>	40	149,5	34,8	MMIT400D_	L/R		
	! Mittelschrank inkl. Abdeckplatte 2 Türen, 3 Glaseinlegeböden inkl. seitlich eingeb. LED-Beleucht. EEK A-A++	30	149,5	34,8	MMIT30LD_	L/R	700.--	869.--
	<i>medium cabinet incl. top 2 doors, 3 glass shelves incl. LED lighting built-in sideways EEC A-A++</i>	40	149,5	34,8	MMIT40LD_	L/R		
	Mittelschrank inkl. Abdeckplatte 1 Tür, 2 Auszüge 2 Glaseinlegeböden	40	149,5	34,8	MMI400D_	L/R	704.--	954.--
<i>medium cabinet incl. top 1 door, 2 extensions 2 glass shelves</i>								
	! Mittelschrank inkl. Abdeckplatte, 1 Tür, 2 Auszüge, 2 Glaseinlegeböden inkl. seitlich eingeb. LED-Beleucht. EEK A-A++	40	149,5	34,8	MMI40LD_	L/R	953.--	1203.--
	<i>medium cabinet incl. top, 1 door, 2 extensions, 2 glass shelves incl. LED lighting built-in sideways EEC A-A++</i>							
	Mittelschrank inkl. Abdeckplatte 2 Türen, 2 Auszüge 2 Glaseinlegeböden	60	149,5	34,8	MMI600D_		938.--	1189.--
<i>medium cabinet incl. top 2 doors, 2 extensions, 2 glass shelves</i>								
	Mittelschrank inkl. Abdeckplatte 4 Türen, 3 Glaseinlegeböden	60	149,5	34,8	MMIT600D_		903.--	1098.--
	<i>medium cabinet incl. top 4 doors, 3 glass shelves</i>				NEU NEW			
	Hochschrank 2 Türen, 4 Glaseinlegeböden	30	178,7	34,8	MHT300D	L/R	532.--	782.--
	<i>tower cabinet</i>	40	178,7	17,6	MHT402D	L/R		
	<i>2 doors, 4 glass shelves</i>	40	178,7	34,8	MHT400D	L/R		
	! Hochschrank 2 Türen, 4 Glaseinlegeböden inkl. seitlich eingeb. LED-Beleucht. EEK A-A++	30	178,7	34,8	MHT30LD	L/R	825.--	1075.--
	<i>tower cabinet</i> <i>2 doors, 4 glass shelves incl. LED lighting built-in sideways EEC A-A++</i>	40	178,7	34,8	MHT40LD	L/R		
	Hochschrank 1 Tür/1 Wäschekippe, 2 Glaseinlegeb.	40	178,7	34,8	MHW400D	L/R	594.--	845.--
<i>tower cabinet</i> <i>1 door/1 linen bin, 2 glass shelves</i>								



! Bitte beachten: Die seitliche LED-Beleuchtung ist immer in der Schrankseite gegenüber des Türanschlages montiert. Beim Highboard mit Wäschekippe muss die gewünschte Seite angegeben werden. / Please note: The lateral LED lighting is always mounted to the side across the door hinge. For the highboard with linen bin it has to be specified.

EEK/EEC= Energieeffizienzklasse/energy efficiency category

Beschreibung <i>Description</i>	Maße in cm <i>Dimensions in cm</i>			Artikel-Nr. <i>Article no.</i>	Türanschlag	Identnummer <i>ID number</i>	
	B/W	H	T/D				

						PG2 matt/matt	PG3 Glanz/gloss	
	! Hochschrank, 1 Tür/1 Wäschekippe, 2 Glaseinlegeböden, inkl. seitl. eingeb. LED-Beleucht. EEK A-A++ <i>tower cabinet, 1 door/1 linen bin, 2 glass shelves incl. LED lighting built-in sideways EEC A-A++</i>	40	178,7	34,8	MHW40LD	L/R	887.--	1137.--
	Hochschrank 2 Türen, 1 Schubkasten 3 Glaseinlegeböden <i>tower cabinet 2 doors, 1 drawer 3 glass shelves</i>	40	178,7	34,8	MH407D	L/R	688.--	938.--
	! Hochschrank, 2 Türen, 1 Schubkasten, 3 Glaseinlegeböden inkl. seitl. eingeb. LED-Beleucht. EEK A-A++ <i>tower cabinet 2 doors, 1 drawer, 3 glass shelves incl. LED lighting built-in sidew. EEC A-A++</i>	40	178,7	34,8	MH407LD	L/R	981.--	1231.--
	Hochschrank 1 Tür, 3 Auszüge 2 Glaseinlegeböden <i>tower cabinet 1 door, 3 extensions 2 glass shelves</i>	40	178,7	34,8	MHA400D	L/R	860.--	1110.--
	! Hochschrank 1 Tür, 3 Auszüge, 2 Glaseinlegeböden inkl. seitlich eingeb. LED-Beleucht. EEK A-A++ <i>tower cabinet 1 door, 3 extensions, 2 glass shelves incl. LED lighting built-in sideways EEC A-A++</i>	40	178,7	34,8	MHA40LD	L/R	1153.--	1403.--
	Hochschrank 2 Türen, 3 Auszüge 2 Glaseinlegeböden <i>tower cabinet 2 doors, 3 extensions 2 glass shelves</i>	60	178,7	34,8	MHA600D		1158.--	1408.--

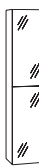
Hochschrank mit Spiegeltür/ *tower cabinet with mirrored door – MSP*

	Hochschrank 2 Spiegeltüren 4 Glaseinlegeböden	40	178,7	17,6	MHST402D	L/R	532.--	782.--
	<i>tower cabinet 2 mirrored doors 4 glass shelves</i>	40	178,7	34,8	MHST400D	L/R		
	! Hochschrank 2 Spiegeltüren, 4 Glaseinlegeböden inkl. seitlich eingeb. LED-Beleucht. EEK A-A++ <i>tower cabinet 2 mirrored doors, 4 glass shelves incl. LED lighting built-in sideways EEC A-A++</i>	40	178,7	34,8	MHST40LD	L/R	825.--	1075.--

! Bitte beachten: Die seitliche LED-Beleuchtung ist immer in der Schrankseite gegenüber des Türanschlages montiert. Beim Highboard mit Wäschekippe muss die gewünschte Seite angegeben werden. / *Please note: The lateral LED lighting is always mounted to the side across the door hinge. For the highboard with linen bin it has to be specified.*

EEK/EEC= Energieeffizienzklasse/energy efficiency category

SPSE(E)801/101
SPSLF(E)801/101

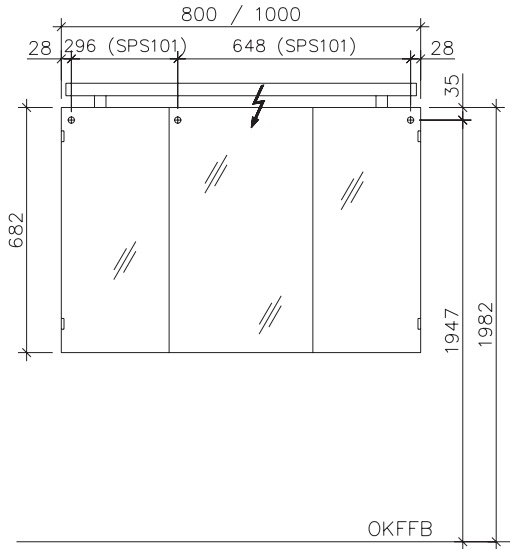

SPSE(E)131
SPSLF(E)131

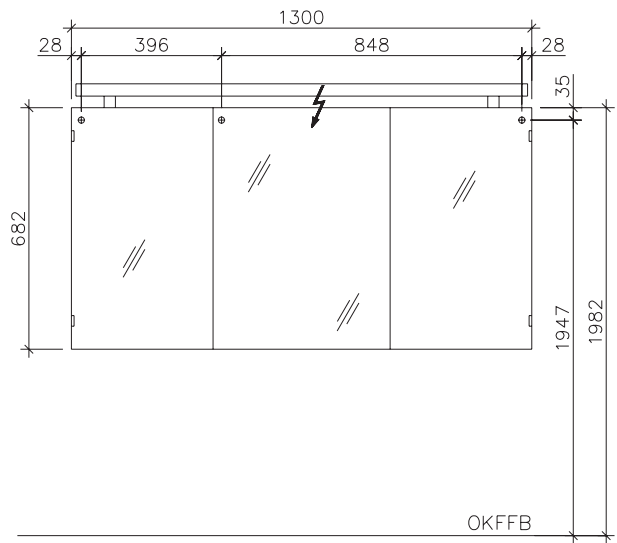

MSPH80/100/120

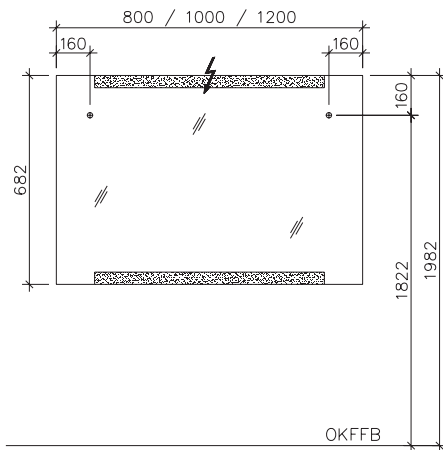

MSPV80/100/120

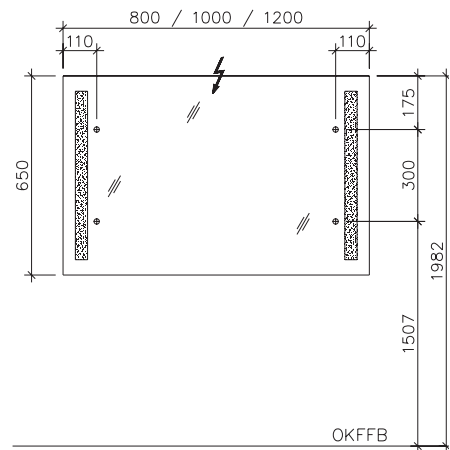

MSPL80/100/120

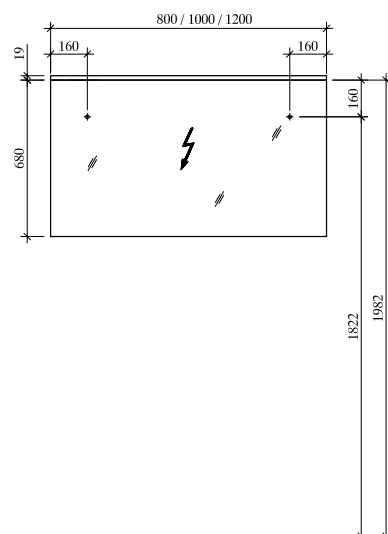

! Achtung: Die Montage muss durch fachkundige Personen erfolgen. Der Untergrund zur Wandbefestigung ist vor Montage zu prüfen. Bitte wählen Sie entsprechend das geeignete Befestigungsmaterial. Fehlerhafte Montagen können das Möbel beschädigen oder dessen Funktion dauerhaft beeinträchtigen. Für Sach- und Personenschäden übernehmen wir im Falle einer unsachgemäßen Montage keine Haftung.
 Attention: Assembly must be carried out by skilled personnel. The subsurface for the wall mounting must be checked before assembly. Please select a suitable mounting material. Faulty assembly can damage furniture or permanently impair its function. We will not be held responsible for damage to material or persons in the case of improper assembly.

MWU_D/MWU_LD/MWU_LED/MWUL132D/MWUL132LED

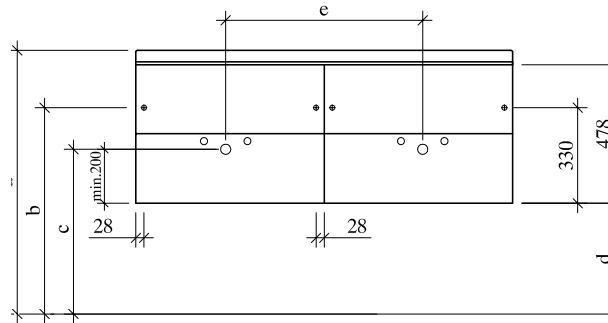

MWU82LD
MWU102LD
MWU132LD-L/LD-R

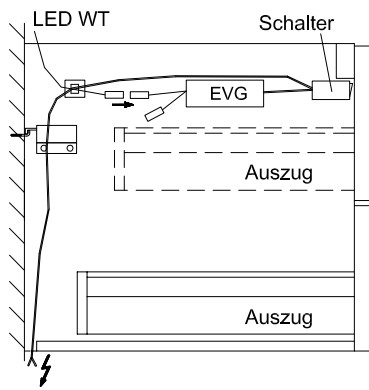

MWU82LED
MWU102LED
MWU132LED-L/LED-R
MWUL132LED-L/LED-R

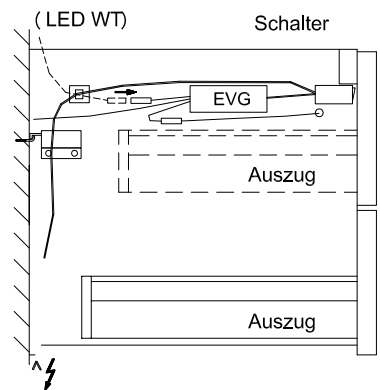

WT-Typ wb type	Art.-Nr. Art. no.	a Gesamthöhe total height	b Schraubhakenhöhe height for wall fix.	c Abflusshöhe height for waste pipe	d Sockelfreiheit distance to floor	e Abstand Abflüsse distance waste pipe	Anzahl Aufhänger number of hooks
Elegance	MWTE80 / MWTE100	900	712	582	382		2
Elegance	MWTEC80 / MWTEC100	910	712	582	382		2
Elegance	MWTEL80 / MWTEL100	900	697	567	367		2
Elegance	MWTED130	900	712	582	382	680 mm	4
Elegance	MWTEDC130	910	712	582	382	680 mm	4
Elegance	MWTEDL130	900	697	567	367	680 mm	4
Polar	MWTP80 / MWTP100	900	697	567	367		2
Polar	MWTPL80 / MWTPL100	900	697	567	367		2
Polar	MWTP130	900	697	567	367	650 mm	4
Polar	MWTPL130	900	697	567	367	650 mm	4
Loft	MWLO80/MWLO100	900	737	607	407		2
Loft	MWLO130	900	737	607	407	650 mm	4
Loft	MWLOL80/MWLOL100	914	737	607	407		2
Loft	MWLO130	914	737	607	407	650 mm	4

! Achtung: Die Montage muss durch fachkundige Personen erfolgen. Der Untergrund zur Wandbefestigung ist vor Montage zu prüfen. Bitte wählen Sie entsprechend das geeignete Befestigungsmaterial. Fehlerhafte Montagen können das Möbel beschädigen oder dessen Funktion dauerhaft beeinträchtigen. Für Sach- und Personenschäden übernehmen wir im Falle einer unsachgemäßen Montage keine Haftung.
 Attention: Assembly must be carried out by skilled personnel. The subsurface for the wall mounting must be checked before assembly. Please select a suitable mounting material. Faulty assembly can damage furniture or permanently impair its function. We will not be held responsible for damage to material or persons in the case of improper assembly.

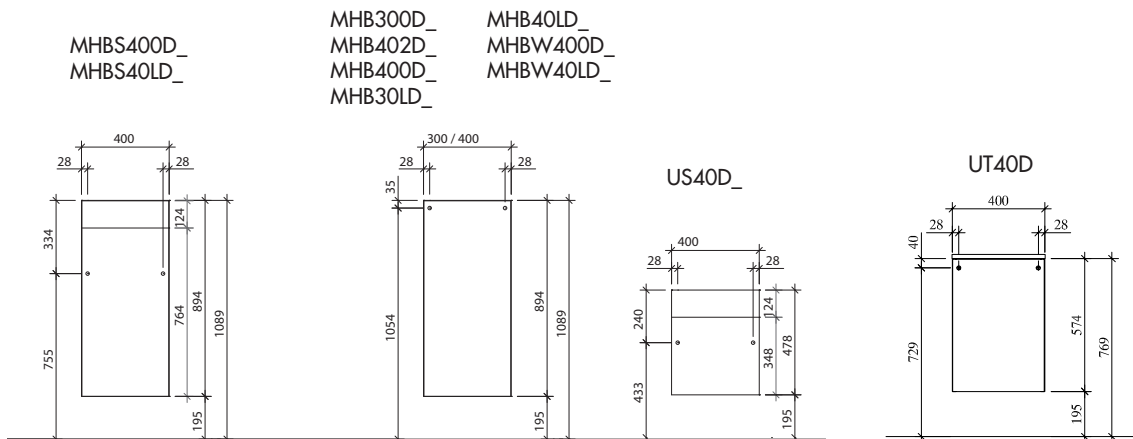
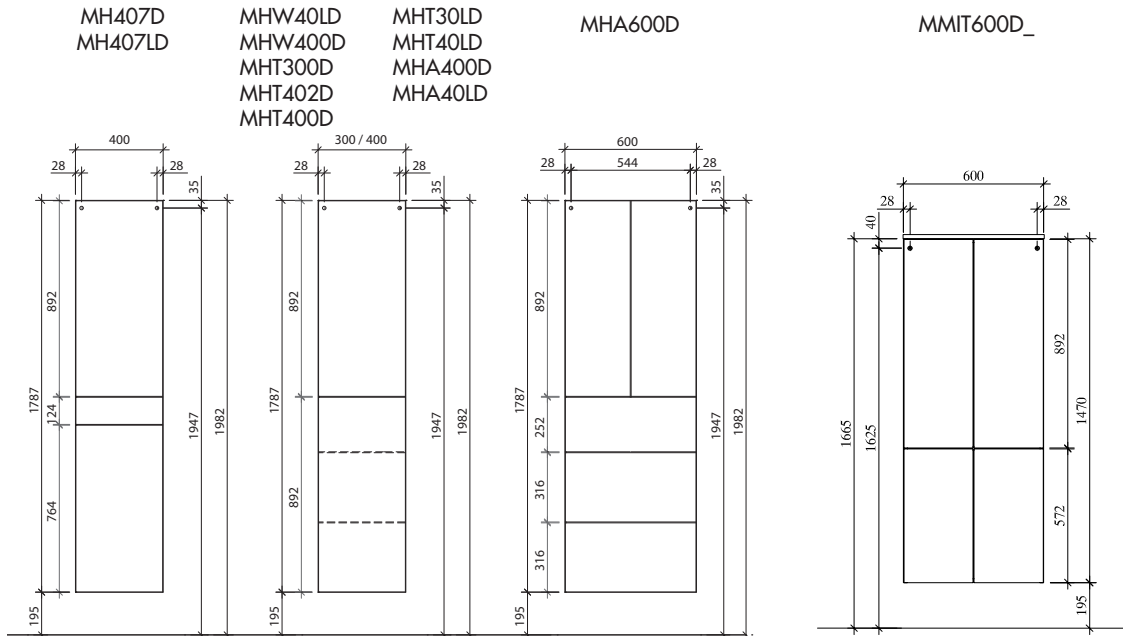
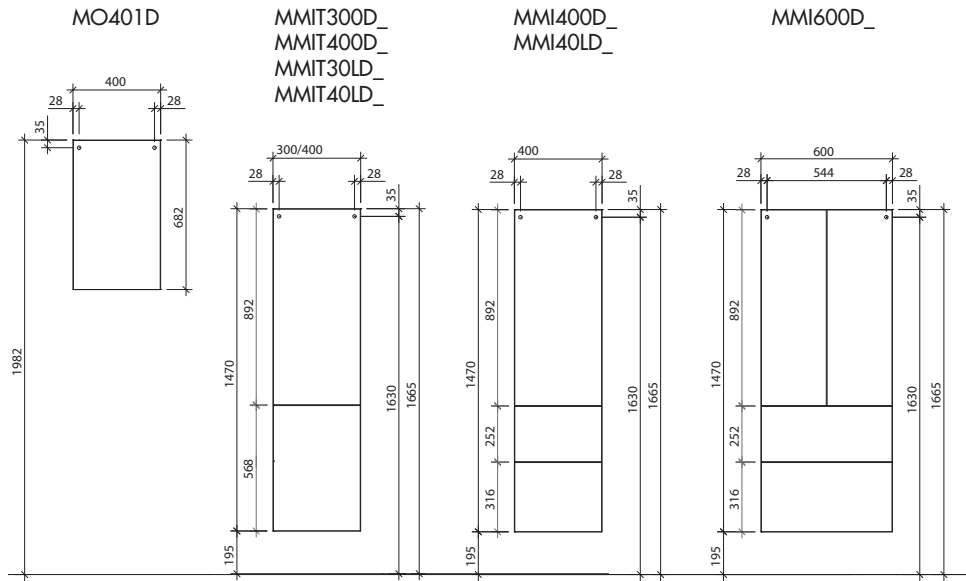

! Achtung: Die Montage muss durch fachkundige Personen erfolgen. Der Untergrund zur Wandbefestigung ist vor Montage zu prüfen. Bitte wählen Sie entsprechend das geeignete Befestigungsmaterial. Fehlerhafte Montagen können das Möbel beschädigen oder dessen Funktion dauerhaft beeinträchtigen. Für Sach- und Personenschäden übernehmen wir im Falle einer unsachgemäßen Montage keine Haftung.
 Attention: Assembly must be carried out by skilled personnel. The subsurface for the wall mounting must be checked before assembly. Please select a suitable mounting material. Faulty assembly can damage furniture or permanently impair its function. We will not be held responsible for damage to material or persons in the case of improper assembly.